

## Plug-in Signal Conditioners M-UNIT

### PULSE DURATION RECEIVER

(field-programmable; built-in excitation)

#### Functions & Features

- Converts the pulse duty ratio into a standard process signal
- Built-in excitation
- Field-selectable input type and range: Dry contact, voltage pulse or two-wire current pulse
- Isolation up to 2000 V AC
- High-density mounting

#### Typical Applications

- Transmission or telemetering
- Converting the pulse duty ratio into an analog momentary values

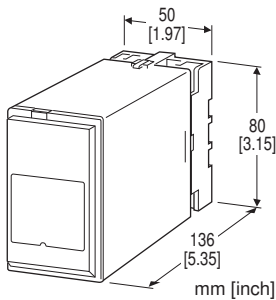

**MODEL: JTY2-[1][2]-[3][4]**

### ORDERING INFORMATION

- Code number: JTY2-[1][2]-[3][4]
- Specify a code from below for each of [1] through [4]. (e.g. JTY2-76-K/Q)
- Special output range (For codes Z & 0)
- Use Ordering Information Sheet (No. ESU-1573). Factory setting (table below) will be used if not otherwise specified.
- Specify the specification for option code /Q (e.g. /C01/S01)

#### Factory Setting

Input type	Voltage pulse
Pulse amplitude range	1 – 5V p-p
Pulse amplitude	5V p-p (DC offset 2.5V)
Pulse logic	Non-inverted *1
Detecting level	Matching the amplitude*2
Input zero duty ratio	0% *3
Input span duty ratio	100% *3
No input detecting time	1 second
Moving average	4 cycles
Moving average Hi/Lo discarded	1 each
Alarm mode	High alarm
Alarm setpoint	100%
Alarm deadband	1%
Alarm delay time at start up	3 seconds
Linearization	Without

\*1. Valid duty ratio

Non-inverted: Hi level for voltage/current pulse  
OFF for open collector

Inverted: Lo level for voltage/current pulse  
ON for open collector

\*2. Detecting voltage in the internal circuit

\*3. Applied to the duty ratio of the selected pulse logic

### INPUT - Field-selectable

Open collector

Voltage pulse

Two-wire current pulse

Described accuracy may not be assured when the input waveform is not clear.

### [1] EXCITATION

1: 5 V DC @ 120 mA

4: 12 V DC @ 60 mA

7: 24 V DC @ 25 mA

### [2] OUTPUT

Current

A: 4 – 20 mA DC (Load resistance 750 Ω max.)

B: 2 – 10 mA DC (Load resistance 1500 Ω max.)

C: 1 – 5 mA DC (Load resistance 3000 Ω max.)

D: 0 – 20 mA DC (Load resistance 750 Ω max.)

E: 0 – 16 mA DC (Load resistance 900 Ω max.)

F: 0 – 10 mA DC (Load resistance 1500 Ω max.)

G: 0 – 1 mA DC (Load resistance 15 kΩ max.)

Z: Specify current (See OUTPUT SPECIFICATIONS)

Voltage

1: 0 – 10 mV DC (Load resistance 10 kΩ min.)

2: 0 – 100 mV DC (Load resistance 100 kΩ min.)

3: 0 – 1 V DC (Load resistance 100 Ω min.)

4: 0 – 10 V DC (Load resistance 1000 Ω min.)

5: 0 – 5 V DC (Load resistance 500 Ω min.)

6: 1 – 5 V DC (Load resistance 500 Ω min.)

4W: -10 – +10 V DC (Load resistance 2000 Ω min.)

5W: -5 – +5 V DC (Load resistance 1000 Ω min.)

0: Specify voltage (See OUTPUT SPECIFICATIONS)

## [3] POWER INPUT

AC Power  
**K:** 85 - 132 V AC  
 DC Power  
**S:** 12 V DC  
**R:** 24 V DC  
**V:** 48 V DC  
**P:** 110 V DC

## [4] OPTIONS

**blank:** none  
**/Q:** With options (specify the specification)

### SPECIFICATIONS OF OPTION: Q (multiple selections)

COATING (For the detail, refer to our web site.)  
**/C01:** Silicone coating  
**/C02:** Polyurethane coating  
**/C03:** Rubber coating  
 TERMINAL SCREW MATERIAL  
**/S01:** Stainless steel

### RELATED PRODUCTS

- Programming Unit (model: PU-2x)
- PC configurator software (model: JXCON)

Downloadable at our web site.  
 A dedicated cable is required to connect the module to the PC. Please refer to the internet software download site or the users manual for the PC configurator for applicable cable types.

### GENERAL SPECIFICATIONS

**Construction:** Plug-in  
**Connection:** M3.5 screw terminals  
**Screw terminal:** Chromated steel (standard) or stainless steel  
**Housing material:** Flame-resistant resin (black)  
**Isolation:** Input to DC output to alarm output to power  
**Overrange output:** Approx. -15 to +115 % at 1 - 5 V  
**Zero adjustment:** -5 to +5 % (front)  
**Span adjustment:** 95 to 105 % (front)  
**Alarm mode:** High or Low  
**Alarm setpoint:** -15 - +115 %  
**Alarm deadband:** 0 - 20 %  
**Linearization:** Max. 16 points  
**Input monitor LED:** Red LED blinks according to the input.  
**Excitation adjustment:** 5 - 24 V DC  
**Software programming:** Programming Unit (model: PU-2x); (Refer to the users manual of JXCON for the adjustments configurable with JXCON)  
 • Input zero and span duty ratio

- No input detecting time
- Moving average
- Alarm setpoint
- Output fine adjustment
- Linearization
- Others

**Adjustments:** With DIP and Rotary switches.

- Pulse amplitude
- Input type

(Refer to the instruction manual for details)

**Modular jack:** Connecting the PU-2x

**Input pulse sensing:** DC coupled

**No input detecting:** The output forced to 0 % or 100 % when no input is provided for a preset time period.

### INPUT SPECIFICATIONS

**Excitation:** Shortcircuit protection; approx. 440 mA (max.) at shortcircuit

**Frequency:** 0.1 - 1000 Hz

(max. 500 Hz for open collector input)

**Duty ratio range:** 1 - 99 % (including 0 and 100 %)

**Minimum span:** 20 % (span duty ratio - zero duty ratio)

#### ■ Open Collector

**Input requirements:**

(Excitation: Sensing)

5 V: Approx. 4 V / 1.0 mA

12 V: Approx. 9 V / 2.3 mA

24 V: Approx. 16 V / 4.7 mA

**ON resistance:**  $\leq 200 \Omega$

**OFF resistance:**  $\geq 200 \text{ k}\Omega$

**Detecting level:** 0 - 5 V

(Readjustment is required to match the duty ratio after the sensor excitation, the pulse amplitude have been changed.)

**Detecting pulse edge:** OFF (input monitor LED ON) to ON (LED OFF) and ON to OFF

#### ■ Voltage Pulse

**Waveform:** Square

**Input impedance:** 10 k $\Omega$  min.

**Pulse amplitude:** 0.1 - 100 Vp-p

**Max. voltage between input terminals:** 50 V

**Detecting level:** 0 - 5

(Readjustment is required to match the duty ratio after the pulse amplitude have been changed.)

**Detecting pulse state:** A pulse rise detected when the input voltage goes above the detecting level (input monitor LED ON); a pulse sink detected when it goes below the level (LED OFF).

#### ■ Two-wire Current Pulse

**Waveform:** Square

**Input resistance:** Receiving resistor 100  $\Omega$

**Input range:** 0 - 25 mA

**Minimum pulse amplitude:** 10 mA

## Detecting level: 0 - 5 V

(Readjustment is required to match the duty ratio after the pulse amplitude have been changed.)

**Detecting pulse state:** The input resistor (100 Ω) converts the current signal into 0 - 2.5 V. A pulse rise detected when the voltage goes above the detecting level (input monitor LED ON); a pulse sink detected when it goes below the level (LED OFF).

### ■ Voltage pulse waveform

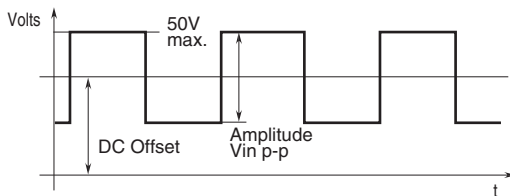

### ■ Two-wire current pulse waveform

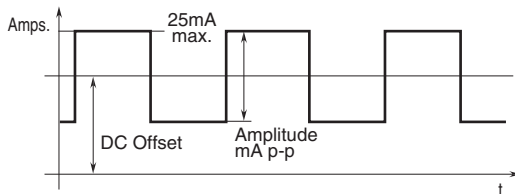

**Operating temperature:** -5 to +60°C (23 to 140°F)

**Operating humidity:** 30 to 90 %RH (non-condensing)

**Mounting:** Surface or DIN rail

**Weight:** 350 g (0.77 lb)

## PERFORMANCE in percentage of span

**Accuracy:** ±0.25 %

**Alarm setpoint accuracy:** ±0.1 %

**Temp. coefficient:** ±0.015 %/°C (±0.008 %/°F)

**Response time:** 0.5 sec. + 1 pulse cycle (0 - 90 %)

**Line voltage effect:** ±0.1 % over voltage range

**Insulation resistance:** ≥ 100 MΩ with 500 V DC

**Dielectric strength:**

2000 V AC @ 1 minute (input to output to power)

1500 V AC @ 1 minute (input or output or power to alarm output)

2000 V AC @ 1 minute (circuit to ground)

## OUTPUT SPECIFICATIONS

■ **DC Current:** 0 - 20 mA DC

**Minimum span:** 1 mA

**Offset:** Max. 1.5 times span

**Load resistance:** Output drive 15 V max.

■ **DC Voltage:** -10 - +12 V DC

**Minimum span:** 5 mV

**Offset:** Max. 1.5 times span

**Load resistance:** Output drive 10 mA max.; 5 mA for negative voltage output; at ≥ 0.5 V

■ **Alarm Output:** Relay contact

**Rated load:** 125 V AC @ 0.5 A (cos φ = 1)

30 V DC @ 0.5 A (resistive load)

**Maximum switching voltage:** 250 V AC or 125 V DC

**Maximum switching power:** 62.5 VA or 60 W

**Minimum load:** 10 mV DC @ 1 mA

**Mechanical life:** 5 × 10<sup>7</sup> cycles (300 cycles/minute)

For maximum relay life with inductive loads, external protection is recommended.

## INSTALLATION

### Power input

•**AC:** Operational voltage range 85 - 132 V, 47 - 66 Hz, approx. 6 VA

•**DC:** Operational voltage range: Rating ±10 %, or 85 - 150 V for 110 V rating; ripple 10 %p-p max.; Approx. 3.3 W (130 mA at 24 V)

**EXTERNAL VIEW**

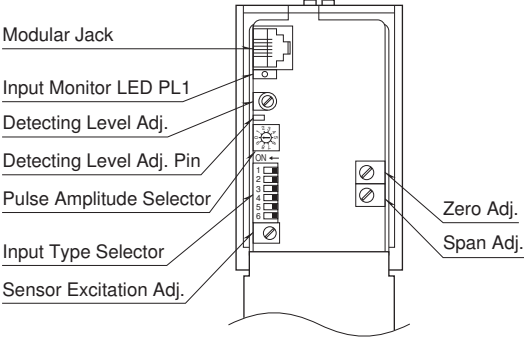

Refer to the instruction manual for detailed procedures.

**INPUT PULSE LOGIC**

INPUT TYPE	PULSE LOGIC	WAVEFORM
Voltage pulse Two-wire current pulse [ON current (H)] [OFF current (L)]	Non-inverted	
	Inverted	
Open collector	Non-inverted	
	Inverted	

The pulse logic is applied to the bold lined section of the waveform.

**EXTERNAL DIMENSIONS & TERMINAL ASSIGNMENTS unit: mm [inch]**

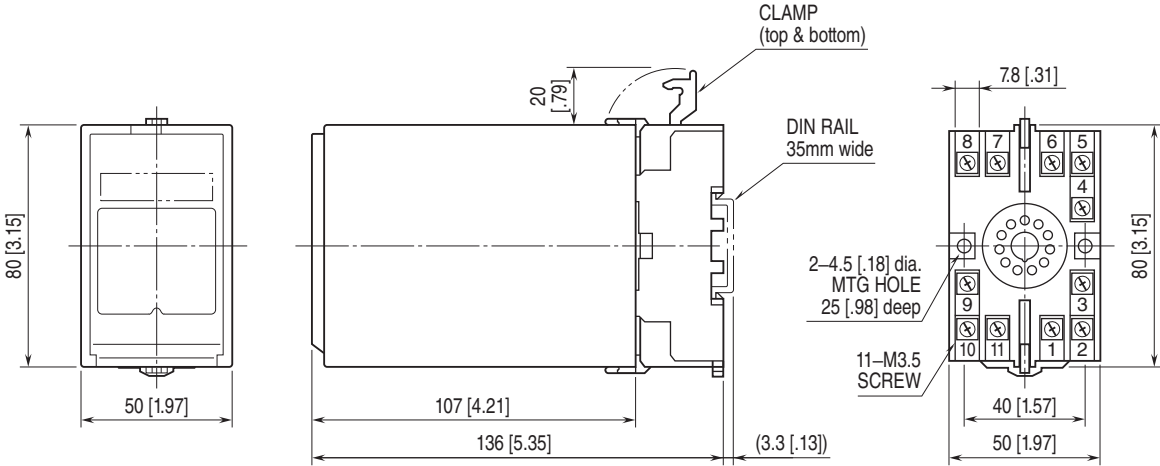

• When mounting, no extra space is needed between units.

**SCHEMATIC CIRCUITRY & CONNECTION DIAGRAM**

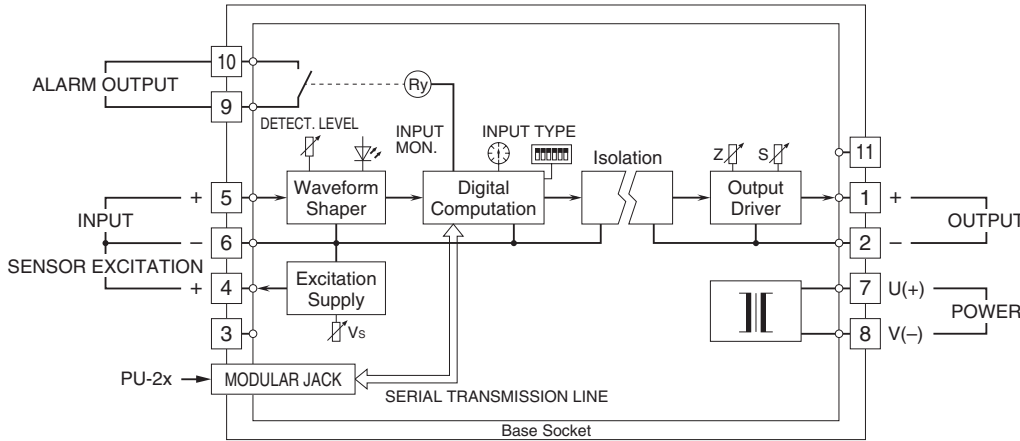

Input Connection Examples

■ Dry Contact

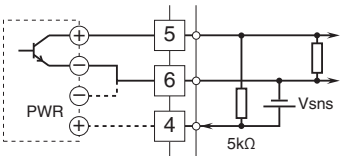

■ 2-Wire Current Pulse  
•Built-in Excitation

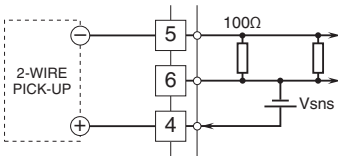

■ Voltage Pulse

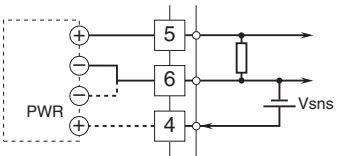

•External DC Supply

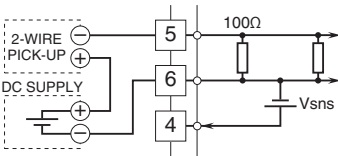

Specifications are subject to change without notice.