

Plug-in Signal Conditioners M-UNIT

UNIVERSAL TRANSMITTER

Functions & Features

- Accepting a direct input from various sensors and providing a standard process signal
- Alarm relay outputs available
- Linearization
- Input type and I/O ranges are programmable via hand-held programmer PU-2x or PC
- Isolation up to 2000 V AC
- High-density mounting

Typical Applications

- Abnormality detection for various devices
- Continuous monitoring
- Ideal for quick spare part

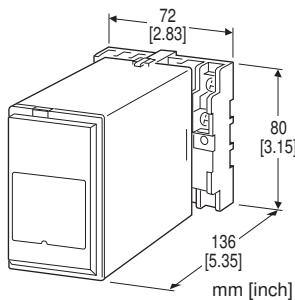

MODEL: JUA-[1][2]

ORDERING INFORMATION

- Code number: JUA-[1][2]
- Specify a code from below for each of [1] and [2].
(e.g. JUA-B/Q)
- Specify the specification for option code /Q
(e.g. /C01/S01)

ITEM	DEFAULT
Input type	1 – 5 V DC
DC output range	4 – 20 mA DC
Alarm outputs	Alarm output 1: Hi trip, 100% Alarm output 2: Lo trip, 0% Deadband (hysteresis): 0.5% Coil energized at alarm ON delay time: 0 sec. Power On delay time: 10 sec.
Linearization	Proportional output
I/O characteristics	Normal

INPUT - Field-selectable

DC Current & Voltage

- **Current:** Usable range ± 50 mA; min. span 0.03 mA
- **Voltage:** Usable range ± 10 V; min. span 3 mV

Thermocouple

(PR), K (CA), E (CRC), J (IC), T (CC)

B (RH), R, S, WRe 5-26, N

3-wire RTD

JPt 100 (JIS '89), Pt 100 (JIS '97, IEC)

2-wire RTD

Pt 100 (JIS '97, IEC)

Potentiometer

Total resistance 100 Ω – 10 k Ω

OUTPUT

DC Current & Voltage

- **Current:** Spans 8 – 20 mA DC
- **Voltage:** Spans 4 – 11.5 V DC

Alarm Output (two)

SPDT or transfer contact

[1] POWER INPUT

AC Power

B: 100 V AC

C: 110 V AC

D: 115 V AC

F: 120 V AC

G: 200 V AC

H: 220 V AC

J: 240 V AC

DC Power

S: 12 V DC

R: 24 V DC

[2] OPTIONS

blank: none

/Q: With options (specify the specification)

SPECIFICATIONS OF OPTION: Q (multiple selections)

COATING (For the detail, refer to our web site.)

/C01: Silicone coating

/C02: Polyurethane coating

/C03: Rubber coating

TERMINAL SCREW MATERIAL

/S01: Stainless steel

RELATED PRODUCTS

- Programming Unit (model: PU-2x)
 - PC configurator software (model: JXCON)
- Downloadable at our web site.

A dedicated cable is required to connect the module to the PC. Please refer to the internet software download site or the users manual for the PC configurator for applicable cable types.

GENERAL SPECIFICATIONS

Construction: Plug-in
Connection: M3.5 screw terminals
Screw terminal: Chromated steel (standard) or stainless steel
Housing material: Flame-resistant resin (black)
Switching: Programming I/O specifications
Isolation: Input to DC output to alarm output to power
Overrange output: Approx. -15 to +115 % at 1 - 5 V
Burnout protection: for T/C or RTD inputs; upscale standard; downscale optional (Choose an output range with suppressed zero [e.g. 1 - 5 V, 4 - 20 mA] for downscale butnout.)
Linearization: 100 points max.
Cold junction compensation (T/C): CJC sensor (included) to be attached to the input terminals
Status indicator LED: Red LED
Alarm monitor LED: Red LEDs turn on when coils are energized.
Programming: Programming Unit (model: PU-2x); input type and range, zero and span, DC output range, simulated output; relay trip action, setpoint and deadband (hysteresis), failsafe relay trip, ON delay time, power ON delay time, inverted output, linearization and burnout.
 Hardware setting with front DIP switches must be done before software programming.
 (Refer to the users manual of JXCON for the adjustments configurable with JXCON.)

INPUT SPECIFICATIONS

■ **DC Current:** -50 - +50 mA DC; input resistor incorporated (100 Ω)
Minimum span: 0.03 mA
Offset: Max. 1.5 times span
 ■ **DC Voltage:** -10 - +10 V DC
Minimum span: 3 mV
Offset: Max. 1.5 times span
Input resistance
 (Input Span: Input Resistance)
 3 mV - 1 V: 50 k (Ω min.)
 ≥ 1 V: 1M
 ■ **Thermocouple**
Minimum span: 3 mV
Offset: Max. 1.5 times span
Input resistance: 50 kΩ min.

Burnout sensing: 0.1μA

■ 3-Wire RTD

Maximum leadwire resistance: 20 Ω per wire

Sensing current: 1 mA

■ 2-Wire RTD

Maximum leadwire resistance: 20 Ω per wire; resistance adjustment required

Sensing current: 1 mA

■ **Potentiometer:** 100 Ω - 10 kΩ

Minimum span: 50 % of total resistance

Excitation: 0.3 V DC

Thermocouple: Temperature range

T/C	USABLE RANGE		MIN. SPAN*1	
	°C	°F	°C	°F
(PR)	0 to 1760	32 to 3200	370	670
K (CA)	-270 to +1370	-454 to +2498	75	140
E (CRC)	-270 to +1000	-454 to +1832	50	90
J (IC)	-210 to +1200	-346 to +2192	60	110
T (CC)	-270 to +400	-454 to +752	75	140
B (RH)*2	0 to 1820	32 to 3308	780	1410
R	-50 to +1760	-58 to +3200	360	650
S	-50 to +1760	-58 to +3200	380	690
WRe 5-26	0 to 2320	32 to 4208	200	400
N	-270 to +1300	-454 to +2372	110	200

*1. Approximate values to obtain 3mVε.m.f. for your reference.

*2. The described accuracy may be partially not satisfied when the temperature ranges below 400°C.

Remark: The described accuracy may be partially not satisfied when the temperature ranges below 0°C. Consult factory.

3-Wire RTD: Temperature range

RTD	USABLE RANGE		MIN. SPAN	
	°C	°F	°C	°F
JPt 100 (JIS '89)	-200 to +500	-328 to +932	50	90
Pt 100 (JIS '97, IEC)	-200 to +850	-328 to +1562	50	90

2-Wire RTD: Temperature range

RTD	USABLE RANGE		MIN. SPAN	
	°C	°F	°C	°F
Pt 100 (JIS '97, IEC)	-200 to +850	-328 to +1562	50	90

OUTPUT SPECIFICATIONS

■ DC Output

• **DC Current:** 0 - 20 mA DC

Minimum span: 8 mA

Offset: Max. 1.5 times span

Load resistance: Output drive 15 V max.

(Output : Load resistance)

4 - 20mA : 750 (Ω max.)

2 - 10mA : 1500

0 - 20mA : 750

0 - 16mA : 900

0 - 10mA : 1500

• **DC Voltage:** 0 - 11.5 V DC

Minimum span: 4 V

Offset: Max. 1.5 times span

Load resistance: Output drive 1 mA max.

(Output: Load resistance)

0 - 10 V : 10 k (Ω min.)

0 - 5 V : 5000

1 - 5 V : 5000

■ **Alarm Output:** Relay contact

Rated load: 120 V AC @ 0.5 A ($\cos \phi = 1$)

240 V AC @ 0.5 A ($\cos \phi = 1$)

30 V DC @ 0.5 A (resistive load)

Maximum switching voltage: 380V AC or 125 V DC

(To conform with EU Directive, limit the voltage to 300 V AC

(Measurement Category I) or 150 V AC (Measurement Category II) or less.)

Maximum switching power: 120 VA or 30 W (≤ 0.5 A)

Minimum load: 5 V DC @ 10 mA

Mechanical life: 5×10^7 cycles

For maximum relay life with inductive loads, external protection is recommended.

Accuracy: ± 0.3 %

Linearization accuracy: ± 0.05 %

Cold junction compensation error: $\pm 0.5^\circ\text{C}$ or $\pm 0.9^\circ\text{F}$ max.

(at $20^\circ\text{C} \pm 10^\circ\text{C}$ or $68^\circ\text{F} \pm 18^\circ\text{F}$)

Burnout response: ≤ 10 sec.

• **RTD input**

Accuracy: $\pm 0.1\%$ or $\pm 0.1^\circ\text{C}$, whichever is greater

(± 0.3 % for 2-wire RTD)

Burnout response: ≤ 10 sec.

• **Potentiometer input**

Accuracy: ± 0.1 %

Setting accuracy: ± 0.3 % + input specific accuracy

Temp. coefficient: ± 0.015 %/ $^\circ\text{C}$ (± 0.008 %/ $^\circ\text{F}$)

(± 0.03 %/ $^\circ\text{C}$ or ± 0.01 %/ $^\circ\text{F}$ for 2-wire RTD)

Response time: ≤ 0.5 sec. (0 - 90 %)

(≤ 0.7 sec. for RTD inputs)

Line voltage effect: ± 0.1 % over voltage range

Insulation resistance: ≥ 100 M Ω with 500 V DC

Dielectric strength: 2000 V AC @1 min. (input to DC output to alarm output to power to ground)

STANDARDS & APPROVALS

EU conformity:

EMC Directive

EMI EN 61000-6-4

EMS EN 61000-6-2

Low Voltage Directive

EN 61010-1

Measurement Category II (alarm output)

Installation Category II (power)

Pollution degree 2

Input or DC output or alarm output to power:

Reinforced insulation (300 V)

Input to DC output to alarm output: Basic insulation (300 V)

RoHS Directive

Alarm Trip Example (Hi/Lo) Terminal No. in parentheses

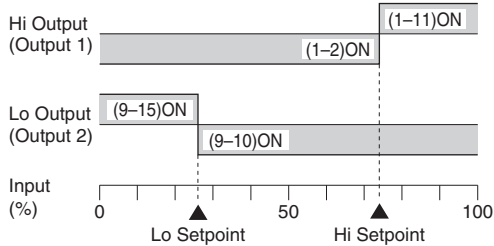

Trip Operation in Power Failure

: Terminals 1 - 2, 9 - 10 turn ON.

INSTALLATION

Power input

• **AC:** Operational voltage range: rating ± 10 %,

50/60 ± 2 Hz, approx. 2.5 VA

• **DC:** Operational voltage range: rating ± 10 %

ripple 10 %p-p max., approx. 2.5 W (105 mA at 24 V)

Operating temperature: -5 to $+55^\circ\text{C}$ (23 to 131°F)

Operating humidity: 30 to 90 %RH (non-condensing)

Mounting: Surface or DIN rail

Weight: 400 g (0.88 lb)

PERFORMANCE in percentage of span

• **DC input**

Accuracy: ± 0.1 %

• **Thermocouple input**

EXTERNAL VIEW

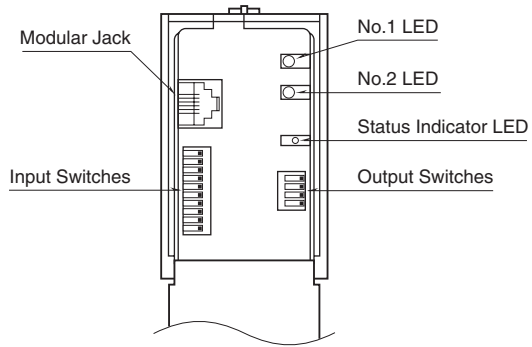

EXTERNAL DIMENSIONS unit: mm [inch]

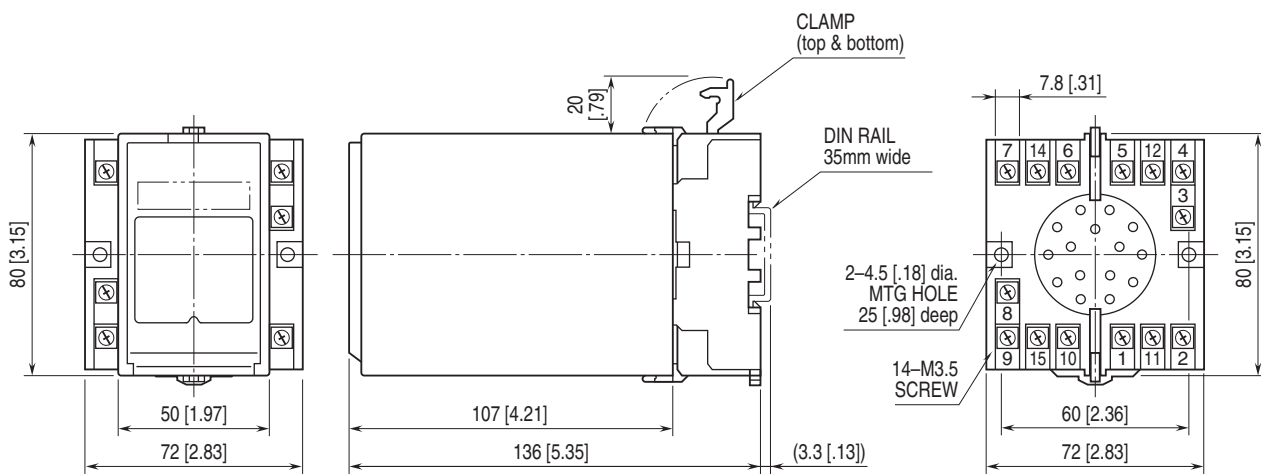

• When mounting, no extra space is needed between units.

TERMINAL ASSIGNMENTS unit: mm [inch]

CJC sensor attached for a thermocouple input.

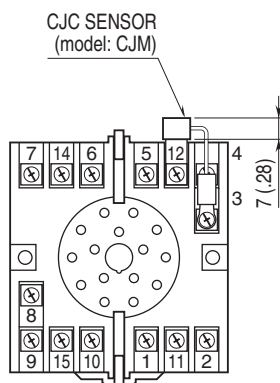

SCHEMATIC CIRCUITRY & CONNECTION DIAGRAM

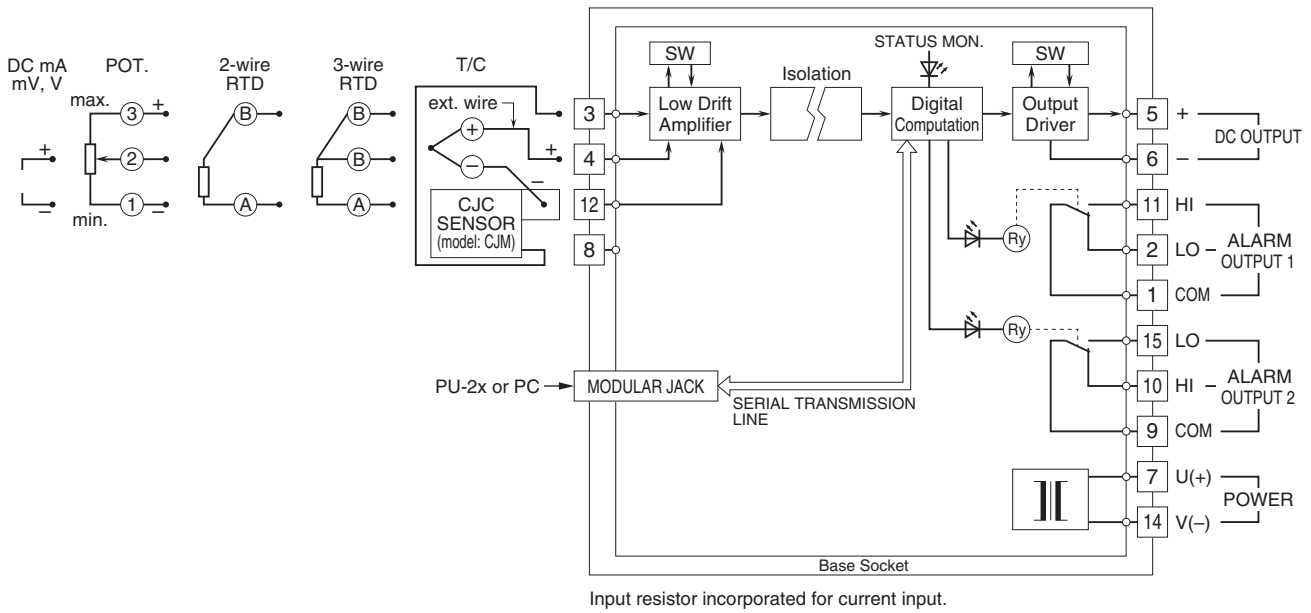

SOFTWARE FUNCTION BLOCK DIAGRAM

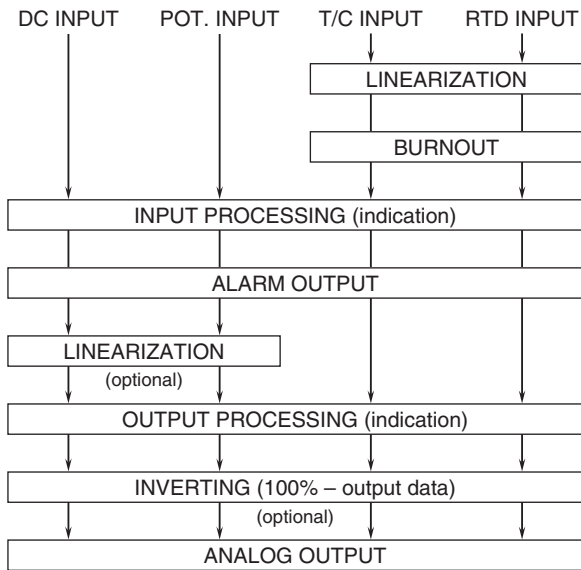

Specifications are subject to change without notice.