

Plug-in Signal Conditioners K-UNIT

6: 220 V / 380 V / 5 A AC

7: 110 V / 190 V / 1 A AC

8: 110 V / 190 V / 5 A AC

VAR TRANSDUCER

(for 3-phase / 4-wire)

Functions & Features

- Providing a DC output signal in proportion to AC reactive power
- DC output containing little ripple is ideal for computer input
- "Time division multiplication" method accepts distorted waveforms
- Isolation up to 2000 V AC
- High-density mounting

Typical Applications

- Centralized monitoring and control of power management system in a manufacturing facility or building

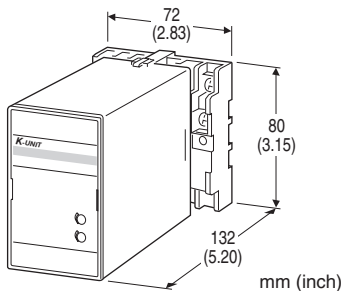

MODEL: KURE-4[1][2][3]-[4][5]

ORDERING INFORMATION

- Code number: KURE-4[1][2][3]-[4][5]
- Specify a code from below for each of [1] through [5]. (e.g. KURE-41PA-C/Q)
- Calibration range (e.g. lag 1000 - 0 - lead 1000 var)
- VT ratio, CT ratio (e.g. VT 3300 / 110 V, CT 250 / 5 A)
- Special output range (For codes Z & 0)
- Specify the specification for option code /Q (e.g. /C01/S01)

CONFIGURATION

4: 3-phase / 4-wire

[1] INPUT (unbalanced load)

(Voltage must be balanced.)

1: 63.5 V / 110 V / 5 A AC

2: 63.5 V / 110 V / 1 A AC

3: 127 V / 220 V / 1 A AC

4: 127 V / 220 V / 5 A AC

5: 220 V / 380 V / 1 A AC

[2] OUTPUT SIGNAL POLARITY

P: Negative in lag, positive in lead

M: Negative in lead, positive in lag

[3] OUTPUT

Current

A: 4 - 20 mA DC (Load resistance 600 Ω max.)

B: 2 - 10 mA DC (Load resistance 1200 Ω max.)

C: 1 - 5 mA DC (Load resistance 2400 Ω max.)

D: 0 - 20 mA DC (Load resistance 600 Ω max.)

E: 0 - 16 mA DC (Load resistance 750 Ω max.)

F: 0 - 10 mA DC (Load resistance 1200 Ω max.)

G: 0 - 1 mA DC (Load resistance 12 kΩ max.)

GW: -1 - +1 mA DC (Load resistance 10 kΩ max.)

Z: Specify current (See OUTPUT SPECIFICATIONS)

Voltage

1: 0 - 10 mV DC (Load resistance 10 kΩ min.)

2: 0 - 100 mV DC (Load resistance 100 kΩ min.)

3: 0 - 1 V DC (Load resistance 1000 Ω min.)

4: 0 - 10 V DC (Load resistance 10 kΩ min.)

5: 0 - 5 V DC (Load resistance 5000 Ω min.)

6: 1 - 5 V DC (Load resistance 5000 Ω min.)

1W: -10 - +10 mV DC (Load resistance 10 kΩ min.)

2W: -100 - +100 mV DC (Load resistance 100 kΩ min.)

3W: -1 - +1 V DC (Load resistance 1000 Ω min.)

4W: -10 - +10 V DC (Load resistance 10 kΩ min.)

5W: -5 - +5 V DC (Load resistance 5000 Ω min.)

0: Specify voltage (See OUTPUT SPECIFICATIONS)

[4] AUXILIARY POWER SUPPLY

AC Power

B: 100 V AC

C: 110 V AC

D: 115 V AC

F: 120 V AC

G: 200 V AC

H: 220 V AC

J: 240 V AC

DC Power

R: 24 V DC

V: 48 V DC

P: 110 V DC

[5] OPTIONS

blank: none

/Q: With options (specify the specification)

SPECIFICATIONS OF OPTION: Q (multiple selections)

COATING (For the detail, refer to our web site.)

/C01: Silicone coating

/C02: Polyurethane coating

/C03: Rubber coating

TERMINAL SCREW MATERIAL

/S01: Stainless steel

GENERAL SPECIFICATIONS

Construction: Plug-in

Connection: M3.5 screw terminals

Screw terminal: Chromated steel (standard) or stainless steel

Housing material: Flame-resistant resin (black)

Isolation: Voltage input to current input to output to auxiliary power

Computation: Time division multiplication

Overrange output: Approx. -10 to +120 % at 1 - 5 V

Zero adjustment: -5 to +5 % (front)

Span adjustment: 95 to 105 % (front)

INPUT SPECIFICATIONS

Frequency: 50 or 60 Hz

• Voltage Input

Operational range: 0 - 120 % of rating

Overload capacity: 150 % of rating for 10 sec., 120 % continuous

• Current Input

Operational range: 0 - 120 % of rating

Overload capacity: 1000 % of rating for 3 sec., 200 % for 10 sec., 120% continuous

■ How To Determine Var Range

Calibration Range [var] = (Measuring Range) ÷ ((VT Ratio) × (CT Ratio))

Check that the required calibration range is within the available range in the table.

[example]

3-phase / 4-wire, measuring range 75 kvar,

VT 127 / 127 V, CT 250 / 5 A

$(75 \times 10^3 \text{ [var]}) \div ((127 \div 127) \times (250 \div 5)) = 1500 \text{ [var]}$

■ INPUT RANGE

• 3-phase / 4-wire

INPUT	STD.RANGE	AVAILABLE RANGE	BURDEN (VA)	
			VOLT.	CURR.
$\frac{110V}{\sqrt{3}} / 1A$	200 var	100 - 240 var	0.1 /phase	0.1 /phase
$\frac{110V}{\sqrt{3}} / 5A$	1000 var	500 - 1200 var		0.5 /phase
$\frac{190V}{\sqrt{3}} / 1A$	350 var	175 - 420 var	0.2 /phase	0.1 /phase
$\frac{190V}{\sqrt{3}} / 5A$	1750 var	875 - 2100 var		0.5 /phase
$\frac{220V}{\sqrt{3}} / 1A$	400 var	200 - 480 var	0.3 /phase	0.1 /phase
$\frac{220V}{\sqrt{3}} / 5A$	2000 var	1000 - 2400 var		0.5 /phase
$\frac{380V}{\sqrt{3}} / 1A$	700 var	350 - 840 var	0.4 /phase	0.1 /phase
$\frac{380V}{\sqrt{3}} / 5A$	3500 var	1750 - 4200 var		0.5 /phase

OUTPUT SPECIFICATIONS

■ **DC Current:** 0 - 20 mA DC and ± 1 mA

Minimum span: 1 mA

Offset: Max. 1.5 times span

Load resistance: Output drive 12 V max.

■ **DC Voltage:** -10 - +12 V DC

Minimum span: 5 mV

Offset: Max. 1.5 times span

Load resistance: Output drive 1 mA max. at ≥ 0.5 V

■ OPERATION DIAGRAM (example)

• Negative in lag, positive in lead

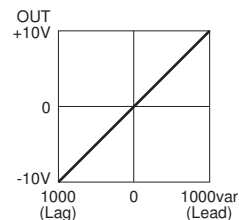
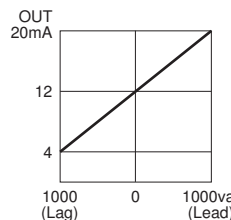

• Negative in lead, positive in lag

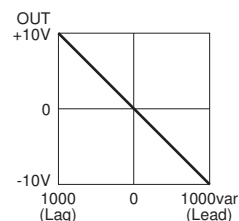
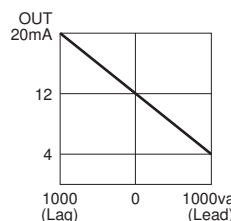

INSTALLATION

Auxiliary power supply

• **AC:** Operational voltage range: rating -15/+10 %, 50/60 Hz, approx. 2 VA

• **DC:** Operational voltage range: rating ± 10 %, or 85 - 150 V for 110 V rating, ripple 10 %p-p max.,

approx. 2 W (18 mA at 110 V)

Operating temperature: -10 to +55°C (14 to 131°F)

Operating humidity: 30 to 85 %RH (non-condensing)

Mounting: Surface or DIN rail

Weight: 500 g (1.1 lb)

PERFORMANCE in percentage of span

Accuracy: $\pm 0.5\%$ (at 23°C $\pm 10^\circ\text{C}$ or 73.4°F $\pm 18^\circ\text{F}$, 45 - 65 Hz)

Response time: ≤ 2 sec. (0 - 100 % $\pm 1\%$)

Ripple: 0.5 %p-p max. (The output ripple may increase when there is great difference between the frequencies of input signal and power supply)

Line voltage effect: $\pm 0.1\%$ over voltage range

Insulation resistance: $\geq 100\text{ M}\Omega$ with 500 V DC

Dielectric strength: 2000 V AC @ 1 minute

(voltage input to current input to output to auxiliary power to ground)

Impulse withstand voltage: 1.2 / 50 $\mu\text{sec.}$, $\pm 5\text{ kV}$

(input to output or ground)

CONNECTION DIAGRAM

3-PHASE/4-WIRE

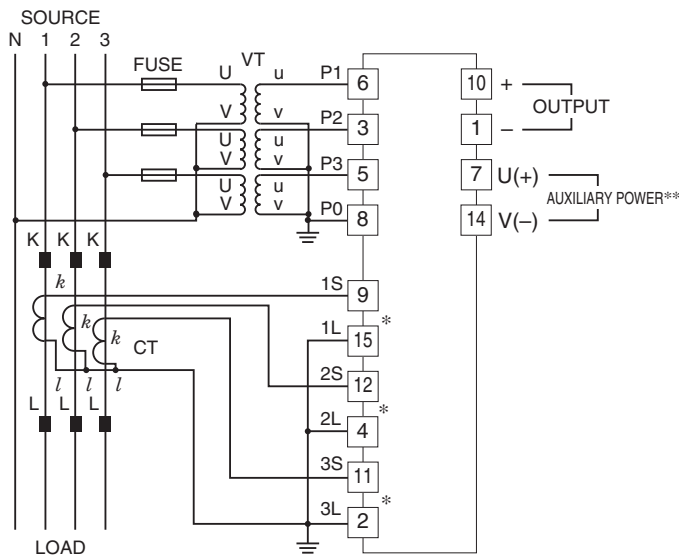

*CT Protector (model: CTM) attached to these terminals.

**The transducer can be powered from the input voltage when the voltage is sufficiently stable and meets within the range of auxiliary power supply of the unit specified in the data sheet/instruction manual.

EXTERNAL DIMENSIONS unit: mm [inch]

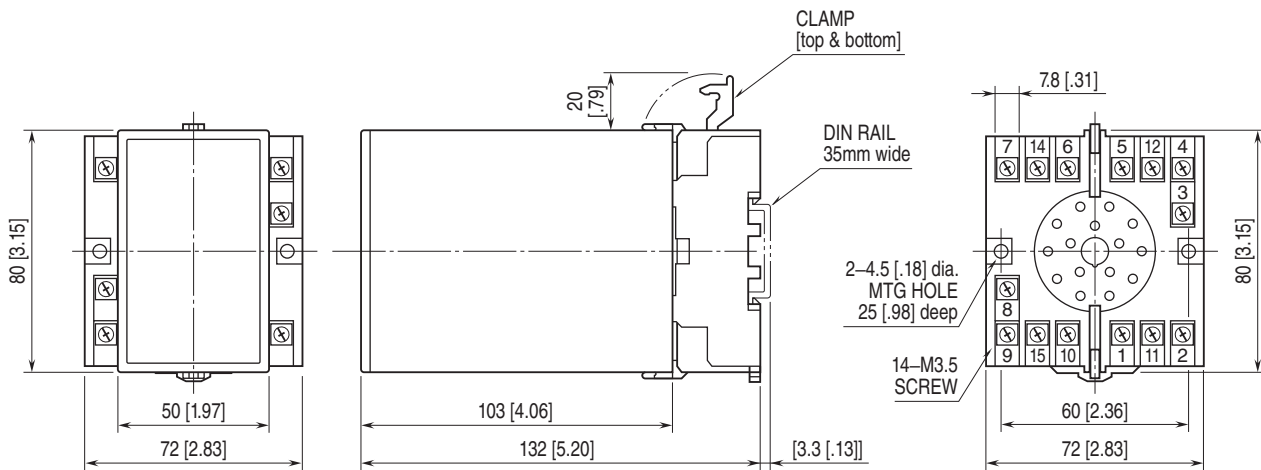

• When mounting, no extra space is needed between units.

TERMINAL ASSIGNMENTS unit: mm [inch]

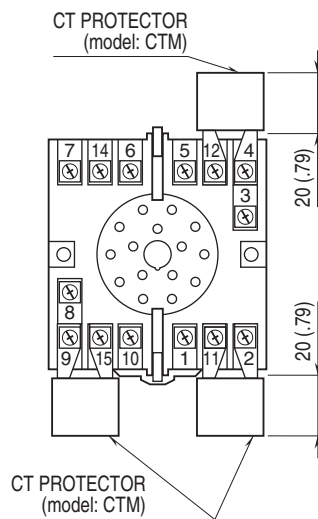

Specifications are subject to change without notice.