

## Lightning Surge Protectors for Electronics Equipment M-RESTER

### LIGHTNING SURGE PROTECTOR FOR AC/DC POWER SUPPLY USE (1A)

(photovoltaic system, instrument shelter)

#### Functions & Features

- Designed for AC and specifically for DC power supplies up to 1 A
- Beneficial for protecting instruments from counter electromotive force by inductors and of course normal lightning surges entering from power supply lines
- 1 A fuse incorporated in element circuit

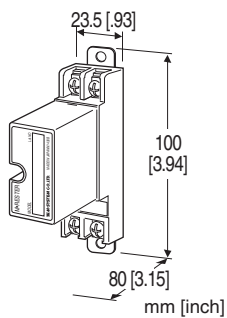

### MODEL: MDP-100T[1]

#### ORDERING INFORMATION

- Code number: MDP-100T[1]  
Specify a code from below for [1].  
(e.g. MDP-100T/A33/Q)
- Specify the specification for option code /Q  
(e.g. /C01)

#### [1] OPTIONS (multiple selections)

DIN Rail Mounting Adapter

**blank:** Without

**/A33:** With adapter (model A-33)

Other Options

**blank:** none

**/Q:** Option other than the above (specify the specification)

#### SPECIFICATIONS OF OPTION: Q

COATING (For the detail, refer to our web site.)

**/C01:** Silicone coating

**/C02:** Polyurethane coating

**/C03:** Rubber coating

#### GENERAL SPECIFICATIONS

**Construction:** Plug-in

**Surge protection type:** Voltage limiting type one-port SPD

**Connection:** M4 screw terminals (torque 0.8 N·m)

**Screw terminal:** Nickel-plated steel

**Housing material:** Flame-resistant resin (black)

#### INSTALLATION

**Operating temperature:** -20 to +80°C (-4 to +176°F)

**Operating humidity:** 30 to 90 %RH (non-condensing)

**Mounting:** Surface or DIN rail

**Weight:**

90 g (0.20 lb), standard

115 g (0.25 lb), with DIN rail mounting adapter

#### PERFORMANCE

**Max. line voltage (Uc):** 120 V AC (peak voltage 170V)

**Discharge voltage:**

Line to line: 190 V

Line to earth: 410 V

**Voltage protection level (Up):**

Line to line: 400 V

Line to earth: 800 V

**Response time:** ≤ 0.1 μsec.

**Leakage current:**

Line to line: ≤ 0.15 mA @ 150 V DC

Line to earth: ≤ 0.15 mA @ 300 V DC

**Max. discharge current (Imax):** 1000 A (8/ 20 μsec.)

**Nominal current (In):** 1.0 A

**Dielectric strength of the base module:**

1500 V AC @ 1 minute (G terminal to other terminals)

**Internal series resistance:** ≤ 0.4 Ω (including return)

**Surge protection:** IEC 61643-1 Class III

**CONNECTION EXAMPLES**

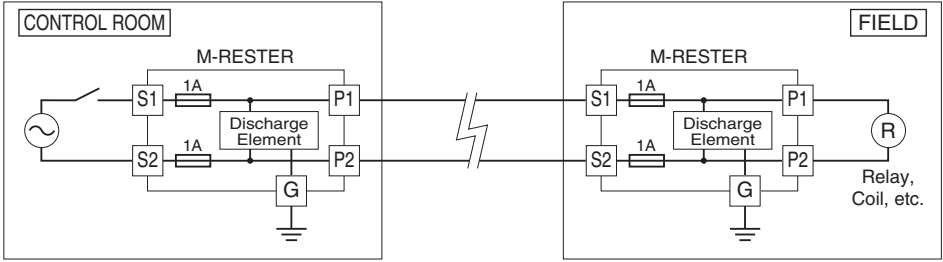

The M-RESTER must be connected with its terminals S1 and S2 faced on power source side in order that the fuses would be blown in case of shortcircuit of the discharge element.

**GROUNDING**

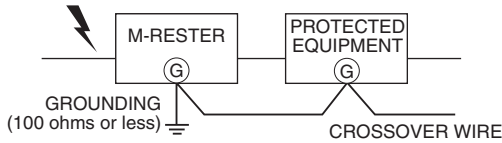

A crossover wire between M-RESTER ground and the ground or metallic housing of the equipment is required for protection. If the protected equipment has no ground terminal, ground the M-RESTER only. When the M-RESTER is mounted with DIN Rail Mounting Adapter, connect the grounding wire to the mounting screw of the M-RESTER.

**EXTERNAL DIMENSIONS & TERMINAL ASSIGNMENTS** unit: mm [inch]

■ STANDARD

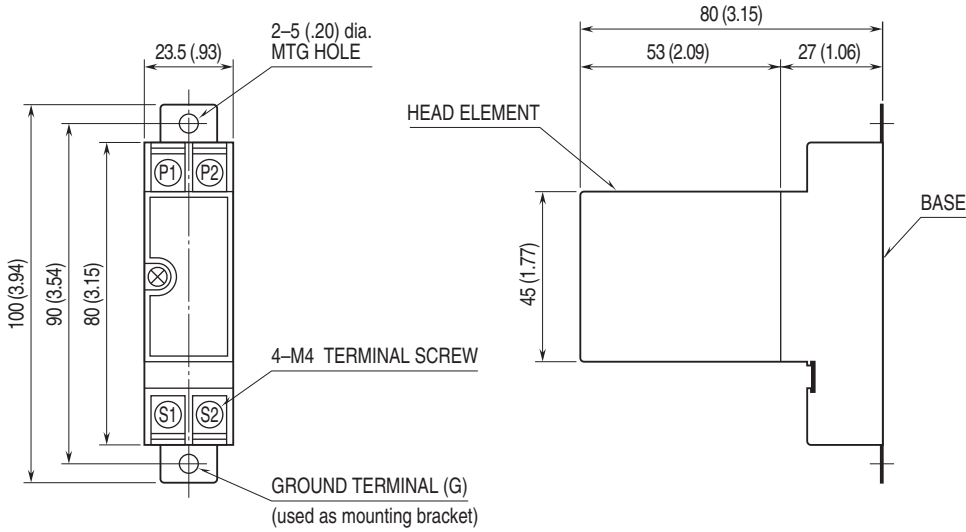

■ WITH DIN RAIL MOUNTING ADAPTER

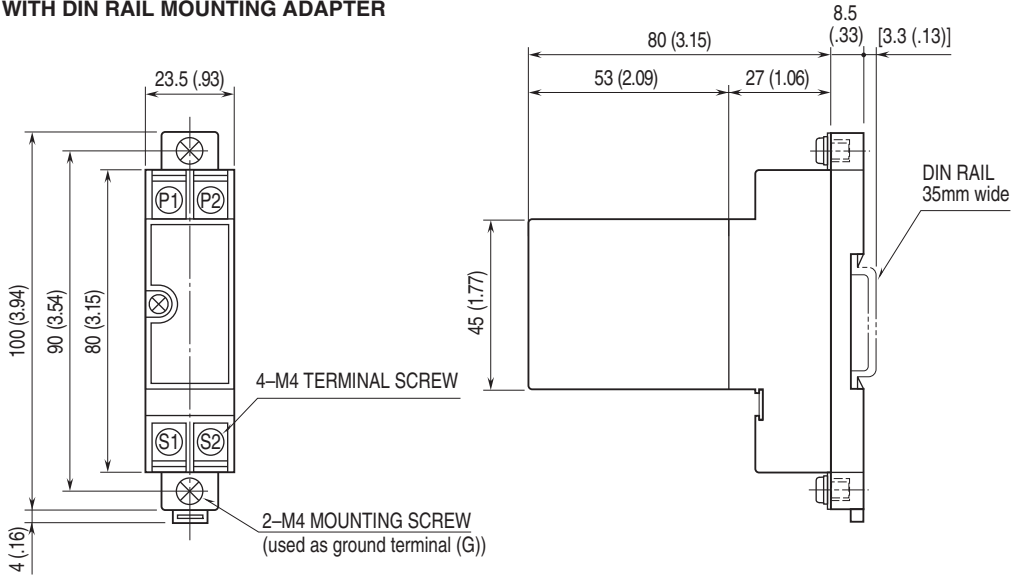

**MOUNTING REQUIREMENTS** unit: mm [inch]

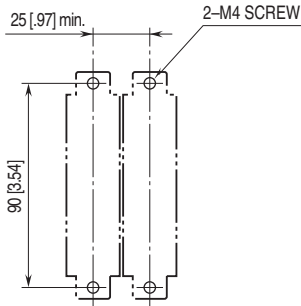

**SCHEMATIC CIRCUITRY & CONNECTION DIAGRAM**

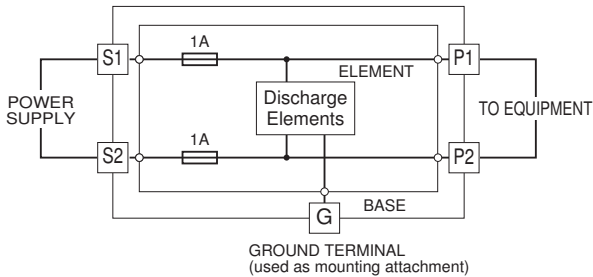

Note: When the head element is removed, the line will be open.



Specifications are subject to change without notice.