

Lightning Surge Protectors for Electronics Equipment M-RESTER

LIGHTNING SURGE PROTECTOR FOR EC-CABLE USE

Functions & Features

- Designed specifically for the 32-point Transmission System EC-CABLE
- Protects the transmitter model ECT and the receiver ECR from lightning surges entering through the twisted-pair cables connecting the both modules
- Applicable to transmission systems by current loops
- Absorbs surges only without affecting instrumentation signal
- No interruption of signal by unplugging the protector element

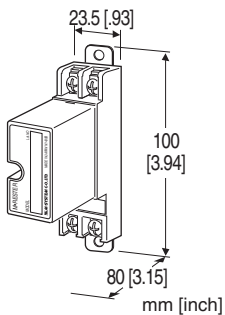

MODEL: MDP-EC[1]

ORDERING INFORMATION

- Code number: MDP-EC[1]
- Specify a code from below for [1].
(e.g. MDP-EC/A33/Q)
- Specify the specification for option code /Q
(e.g. /C01)

[1] OPTIONS (multiple selections)

DIN Rail Mounting Adapter

blank: Without

/A33: With adapter (model A-33)

Other Options

blank: none

/Q: Option other than the above (specify the specification)

SPECIFICATIONS OF OPTION: Q

COATING (For the detail, refer to our web site.)

/C01: Silicone coating

/C02: Polyurethane coating

/C03: Rubber coating

GENERAL SPECIFICATIONS

Construction: Plug-in

Connection: M4 screw terminals (torque 0.8 N·m)

Screw terminal: Nickel-plated steel

Housing material: Flame-resistant resin (black)

INSTALLATION

Operating temperature: -5 to +55°C (23 to 131°F)

Operating humidity: 30 to 90 %RH (non-condensing)

Mounting: Surface or DIN rail

Weight:

120 g (0.26 lb), standard

145 g (0.32 lb), with DIN rail mounting adapter

PERFORMANCE

Max. continuous operating voltage (Uc):

Line to line: ±12 V

Line to earth: ±500 V

Voltage protection level (Up):

• @ 1 kV (100 A)

Line to line: ±25 V

Line to earth: ±650 V

• @ 2 kV (1 kA)

Line to line: ±30 V

Line to earth: ±800 V

Response time: ≤ 0.1 μsec.

Leakage current:

Line to line: ≤ 10 μA @ ±12 V DC

Line to earth: ≤ 10 μA @ ±140 V DC

Max. discharge current (Imax): 5000 A (8 / 20 μs)

Nominal current (In): 100 mA

Internal series resistance: 20 Ω ±10 % (including return)

Capacitance @ 1 MHz:

Line to line: ≤ 1000 pF

Line to earth: ≤ 100 pF

Surge protection: IEC 61643-21 Categories C1, C2

CONNECTION EXAMPLES

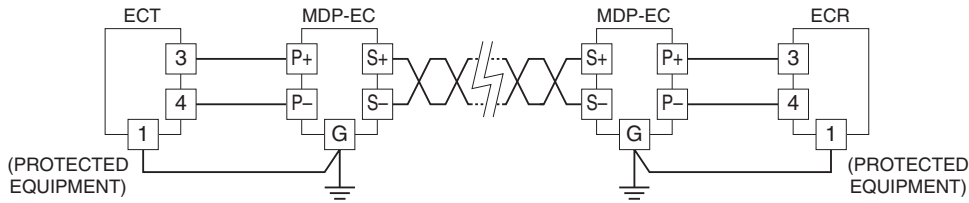

GROUNDING

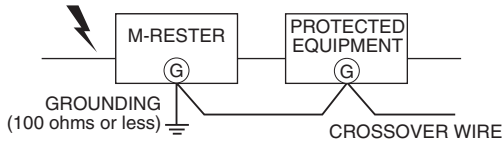

A crossover wire between M-RESTER ground and the ground or metallic housing of the equipment is required for protection.
 If the protected equipment has no ground terminal, ground the M-RESTER only.
 When the M-RESTER is mounted with DIN Rail Mounting Adapter, connect the grounding wire to the mounting screw of the M-RESTER.

EXTERNAL DIMENSIONS & TERMINAL ASSIGNMENTS unit: mm [inch]

■ STANDARD

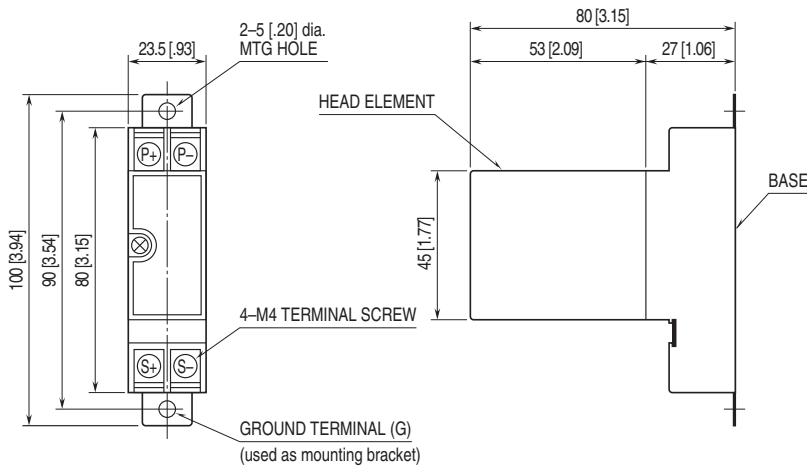

■ WITH DIN RAIL MOUNTING ADAPTER

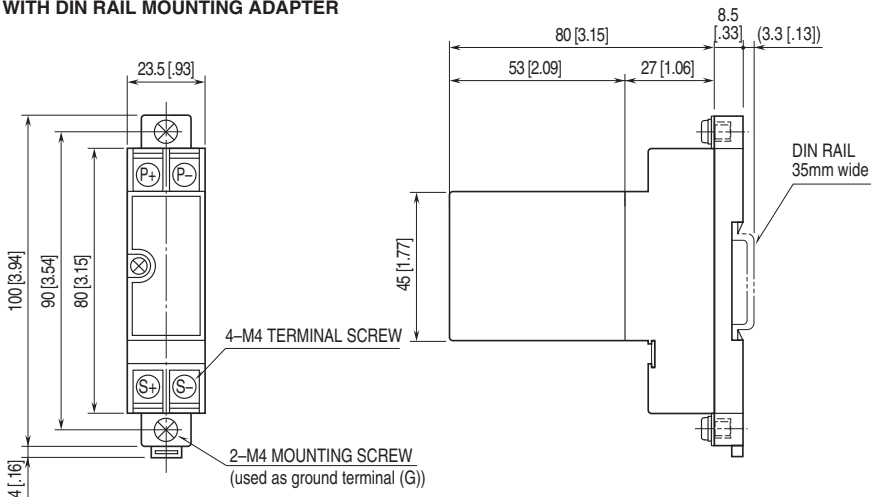

MOUNTING REQUIREMENTS unit: mm [inch]

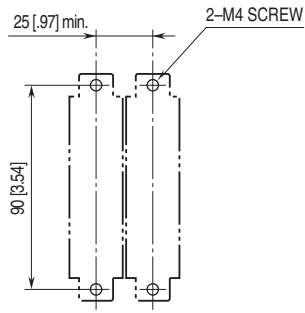

SCHEMATIC CIRCUITRY & CONNECTION DIAGRAM

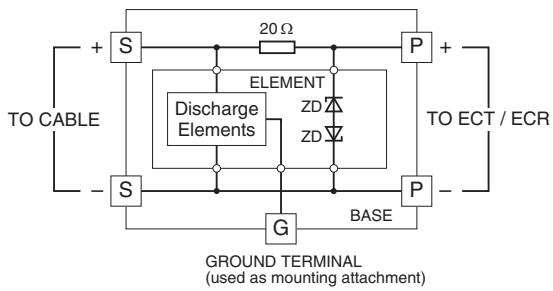

Specifications are subject to change without notice.