

Super-mini Signal Conditioners Mini-M Series

PULSE SCALER

(field-configurable)

Functions & Features

- Converts pulse rate into convenient engineering unit for display on a totalizing counter or meter
- Excitation
- Scaling factor adjustable of 1.0000×10^0 to 0.0001×10^{-6}
- Various outputs (open collector, voltage pulse and AC/DC switch)
- Three-way isolation

Typical Applications

- Positive displacement flowmeters and turbine flowmeters
- Magnetic tachometers

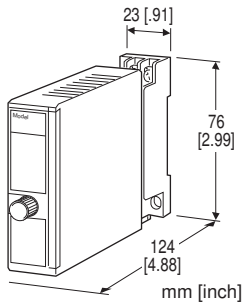

MODEL: M2PRU-[1][2][3]-[4][5]

ORDERING INFORMATION

- Code number: M2PRU-[1][2][3]-[4][5]
- Specify a code from below for each of [1] through [5].
(e.g. M2PRU-A24A-M2/CE/Q)
- Scaling factor (e.g. 0.7000×10^{-2})
- Specify the specification for option code /Q
(e.g. /C01/S01)

[1] INPUT

- A1:** Open collector
- A2:** Mechanical contact
- C:** Voltage pulse (sensitivity 2 V)
- H:** Two-wire current pulse

[2] EXCITATION

- 4:** 12 V DC / 30 mA
- 7:** 24 V DC / 30 mA

[3] OUTPUT

- A:** Open collector (max. 100 kHz)
- M:** 5 V pulse (max. 100 kHz)
- N:** 12 V pulse (max. 100 kHz)
- P:** 24 V pulse (max. 100 kHz)
- R:** AC/DC switch (max. 1 kHz)
- (‘/UL’ is not selectable for ‘Standards & Approvals’ code.)
- () = Max. frequency

[4] POWER INPUT

- AC Power
- M2:** 100 – 240 V AC (Operational voltage range 85 – 264 V, 47 – 66 Hz)
- (90 – 264 V for UL)
- DC Power
- R:** 24 V DC
- (Operational voltage range 24 V \pm 10 %, ripple 10 %p-p max.)
- R2:** 11 – 27 V DC
- (Operational voltage range 11 – 27 V, ripple 10 %p-p max.)
- (Select ‘/N’ for ‘Standards & Approvals’ code.)
- P:** 110 V DC
- (Operational voltage range 85 – 150 V, ripple 10 %p-p max.)
- (110 V \pm 10 % for UL)

[5] OPTIONS (multiple selections)

- Standards & Approvals (must be specified)
- /N:** Without CE or UL
- /CE:** CE marking
- /UL:** UL approval, CE marking
- Other Options
- blank:** none
- /Q:** Option other than the above (specify the specification)

SPECIFICATIONS OF OPTION: Q (multiple selections)

- COATING (For the detail, refer to our web site.)
- /C01:** Silicone coating
- /C02:** Polyurethane coating
- /C03:** Rubber coating (UL not available)
- /C04:** Polyolefin coating (UL not available)
- TERMINAL SCREW MATERIAL
- /S01:** Stainless steel (UL not available)

CAUTION

- 1) The M2PRU's output waveform is not uniform due to its scaling method. The user must be aware that it may be inconvenient for certain types of application.
 - 2) The M2PRU is designed to accept at the maximum of 100 kHz, which may cause errors due to chattering in the input pulses.
- A filter circuitry (time constant: approx. 1 msec.) is incorporated to eliminate unwanted chattering when the mechanical contact input is specified. It is effective for most relay types, however, an external CR filter as indicated below, could be added if the user need improvement. Limit the input frequency to 10 Hz at maximum.

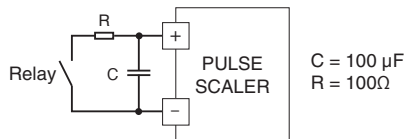

GENERAL SPECIFICATIONS

Construction: Plug-in

Connection: M3 screw terminals (torque 0.8 N·m)

Screw terminal: Chromated steel (standard) or stainless steel

Housing material: Flame-resistant resin (black)

Isolation: Input to output to power

Chattering protection: Filter provided for mechanical contact input (time constant: approx. 1 msec.)

Input pulse sensing: DC coupled; capacitor coupling (automatic trigger*) is field selectable with the side DIP switch for the voltage pulse input.

*Capacitor coupling, with which the detecting levels are automatically set within two peaks of the waveforms, is effective way to detect those with DC offset. However, it may be ineffective if the duty ratio is extremely high or low. The automatic trigger method can compensate such irregular pulses.

Scaling factor adjustment: 10-position rotary switch; $1.0000 \times 10^0 - 0.0001 \times 10^{-6}$; factory set to 1.0000×10^0 if not specified when ordering

Output pulse width adjustment: Single-turn screwdriver adjustment (front); 5 μ sec. - 400 msec. (one-shot type); Factory set to 5 μ sec. except for the mechanical contact input set to 15 msec. or AC/DC switch output set to 500 μ sec.

(Min. 400 μ sec. recommended for AC/DC switch output of which the internal voltage drop value may increase with a shorter pulse width.)

Output pulse width range selector: Double-throw SW (front)

INPUT SPECIFICATIONS

Excitation: Shortcircuit protection; limited to approx. 40 mA at shortcircuit

■ Open Collector

Frequency range: 0 - 100 kHz

Pulse width time requirement: Min. 5 μ sec. for ON and OFF

Sensing: Approx. 24 V DC @2 mA

Detecting levels: $\leq 400 \Omega / 0.8$ V for ON,
 $\geq 1200 \Omega / 2.4$ V for OFF

■ Mechanical Contact

Frequency range: 0 - 30 Hz

Pulse width time requirement: Min. 10 msec. for ON and OFF

Sensing: Approx. 24 V DC @2 mA

Detecting levels: $\leq 400 \Omega / 0.8$ V for ON,
 $\geq 1200 \Omega / 2.4$ V for OFF

■ Voltage Pulse

Waveform: Square or sine

Frequency range: 0 - 100 kHz

(min. 10 Hz for sine waves)

Pulse width time requirement: ≥ 5 μ sec. for high and low levels

Input impedance: ≥ 10 k Ω

Max. input voltage across the terminals: ± 50 V

Detecting levels

DC coupled: ≥ 2 V DC for high level; ≤ 1 V DC for low level

Capacitor coupled: ≥ 2 Vp-p

■ Two-wire Current Pulse

Frequency range: 0 - 100 kHz

Pulse width time requirement: Min. 5 μ sec. for high and low levels

Detecting levels:

≥ 10 mA for high level

≤ 5 mA for low level

Maximum current: ± 30 mA

Input resistance: Receiving resistor 200 Ω

OUTPUT SPECIFICATIONS

■ **Open Collector:** 50 V DC @200 mA (resistive load)

Maximum frequency: 100 kHz

Saturation voltage: 0.6 V DC

■ **Voltage Pulse**

Maximum frequency: 100 kHz

High level: Rating (5, 12 or 24 V) $\pm 10\%$

Low level: ≤ 0.5 V

Load resistance:

$\geq 500 \Omega$ for 5 V

$\geq 1200 \Omega$ for 12 V

$\geq 4800 \Omega$ for 24 V

■ **AC/DC Switch**

132 V AC @200 mA ($\cos \phi = 1$)

30 V DC @200 mA (resistive load)

Maximum frequency: 1 kHz

Internal voltage drop: ≤ 3 V

AC/DC switch output

Input or output to power: Reinforced insulation (300 V)

Input to output: Reinforced insulation (300 V)

RoHS Directive

Approval:

UL/C-UL nonincendive Class I, Division 2,

Groups A, B, C, and D

(ANSI/ISA-12.12.01, CAN/CSA-C22.2 No.213)

UL/C-UL general safety requirements

(UL 61010-1, CAN/CSA-C22.2 No.61010-1)

INSTALLATION

Power Consumption

•**AC:**

Approx. 4 VA at 100 V

Approx. 5 VA at 200 V

Approx. 6 VA at 264 V

•**DC:** Approx. 3 W

Operating temperature: -5 to +55°C (23 to 131°F)

Operating humidity: 30 to 90 %RH (non-condensing)

Mounting: Surface or DIN rail

Weight: 150 g (0.33 lb)

PERFORMANCE

Response time: 25 μ sec. + input cycle + output cycle
(time required for the first pulse to be output from a train of pulse input)

Insulation resistance: ≥ 100 M Ω with 500 V DC

Dielectric strength: 2000 V AC @1 minute (input to output to power to ground)

STANDARDS & APPROVALS

EU conformity:

EMC Directive

EMI EN 61000-6-4

EMS EN 61000-6-2

Low Voltage Directive

EN 61010-1

Measurement Category II (output)

Installation Category II (power)

Pollution Degree 2

Open collector/voltage pulse output

Input or output to power: Reinforced insulation (300 V)

Input to output: Basic insulation (300 V)

EXTERNAL VIEW

FRONT VIEW (with cover open)

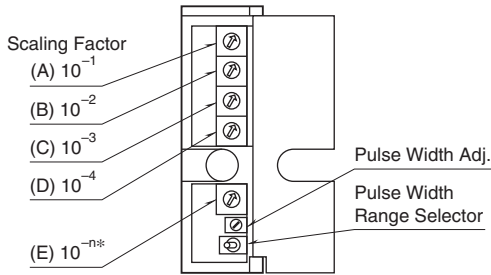

*Settings 7 through 9 are invalid.
No pulse output with these settings.
The front cover cannot be opened to 180 deg.
when flush with neighboring units.

RIGHT SIDE VIEW

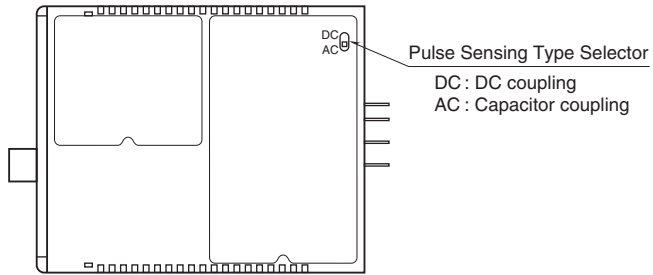

SCALING FACTOR

Positions for the rotary switches 10^{-1} through 10^{-n} apply respectively to each digit of the decimals and exponential as shown below.

Output Rate = Input Rate \times 0.(A)(B)(C)(D) $\times 10^{-E}$
where the scaling factor is adjustable from
 1.0000×10^{-0} thr. 0.0001×10^{-6}

[Examples]

Scaling factor 0.1440:

(A) = 1, (B) = 4, (C) = 4, (D) = 0, (E) = 0

Scaling factor 1.0000 is special:

(A) = 0, (B) = 0, (C) = 0, (D) = 0

PULSE WIDTH

Factory adjusted to a suitable value. Use only when the output device (counter) is not able to read the output pulses.
Min. 400 μ sec. recommended for AC/DC switch output of which the internal voltage drop value may increase with a shorter pulse width.

OUTPUT TYPE	VOLTAGE PULSE	OPEN COLLECTOR AC/DC SWITCH
Bold section of the waveform is adjustable.		OFF ON

PULSE WIDTH RANGE

Selects adjustable range of the output pulse width.

L (Left) : Approx. 0.2 – 10 msec.

CTR (Center): Approx. 5 – 200 μ sec.

R (Right) : Approx. 10 – 400 msec.

PULSE SENSING TYPE

Provided only when the voltage pulse input is selected. Factory set to 'DC coupling.'

When the DC offset is too large to detect by DC coupling, switch to 'Capacitor coupling.'

Refer to the instruction manual for detailed procedures.

EXTERNAL DIMENSIONS & TERMINAL ASSIGNMENTS unit: mm [inch]

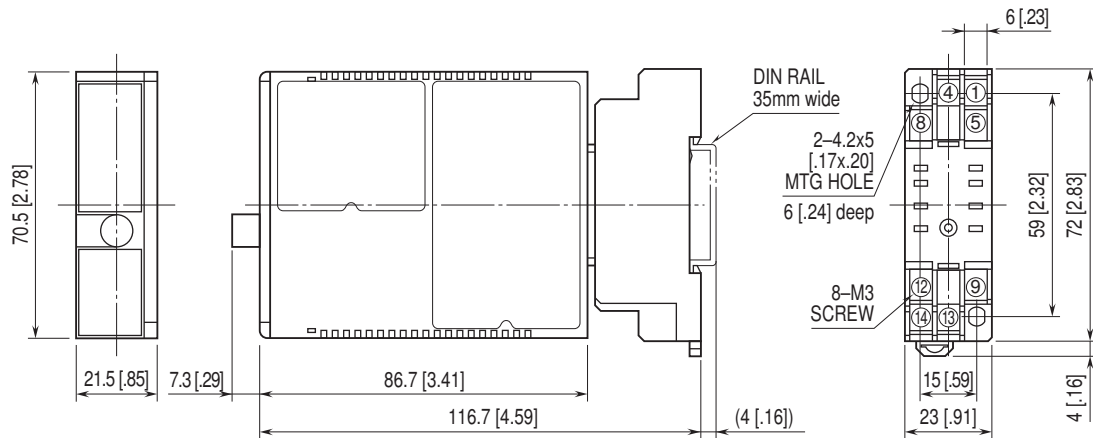

• When mounting, no extra space is needed between units.

SCHEMATIC CIRCUITRY & CONNECTION DIAGRAM

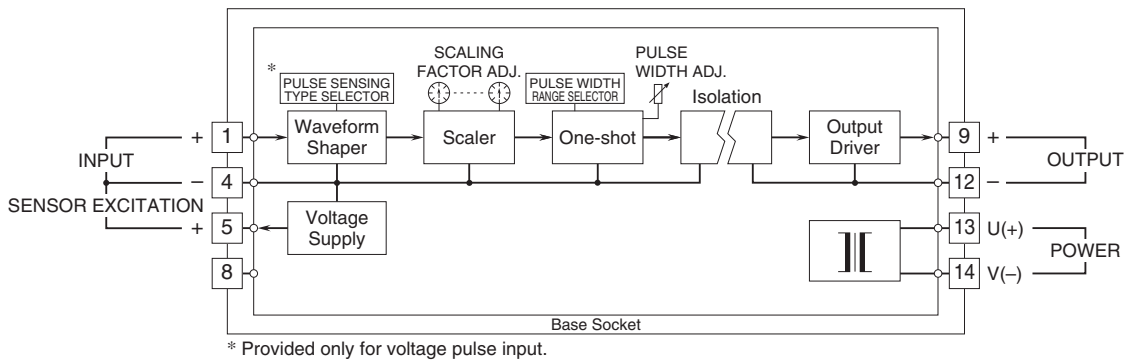

Input Connection Examples

■ Mechanical Contact Open Collector

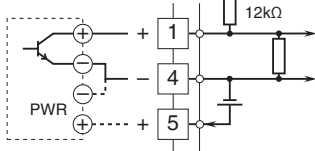

■ 2-Wire Current Pulse Built-in Excitation

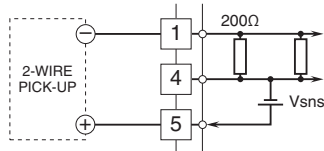

Output Connection Examples

■ Open Collector

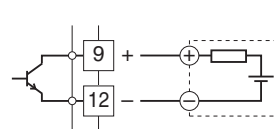

■ Voltage Pulse

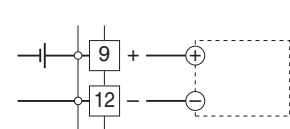

■ Voltage Pulse DC Coupled

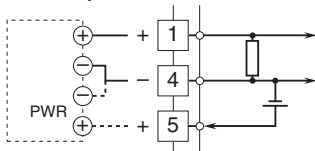

• External DC Supply

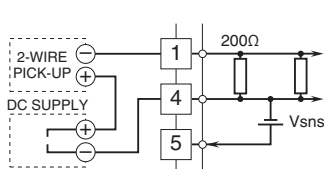

■ AC/DC SWITCH

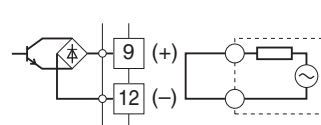

• Capacitor Coupled

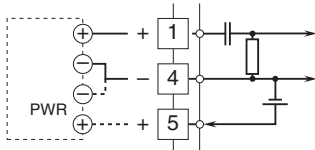



Specifications are subject to change without notice.