

## Super-mini Signal Conditioners Mini-M Series

### SIGNAL TRANSMITTER

(PC programmable)

#### Functions & Features

- Converts DC input from a sensor into a standard process signal
- PC programmable

#### Typical Applications

- Isolation between control room and field instrumentation
- Ideal for quick spare part

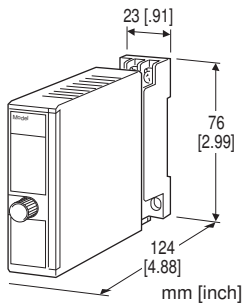

### MODEL: M2XV2-[1][2]-[3][4]

#### ORDERING INFORMATION

- Code number: M2XV2-[1][2]-[3][4]
- Specify a code from below for each of [1] through [4].  
(e.g. M2XV2-S2Z1-R/CE/Q)
- Input range (e.g. 1 - 5 V DC)
  - Output range (e.g. 4 - 20 mA DC)
- Specify the specification for option code /Q  
(e.g. /C01/S01)

#### [1] INPUT

Current

**Z1:** Range 0 - 50 mA DC (Input resistance 100 Ω)

Voltage

**S1:** Range -1 - +1 V DC (Input resistance 1 MΩ min.)

**S2:** Range -10 - +10 V DC (Input resistance 1 MΩ min.)

(Configurator software is used to change input over the described range of the selected suffix code. For changing out of this range (between S1 and S2), set the Input Range Selector on the side of unit before software adjustment. For a current input, set the Selector to the same setting as for S2 and use a receiving resistor.)

#### [2] OUTPUT

Current

**Z1:** Range 0 - 20 mA DC

Voltage

**V1:** Range -2.5 - +2.5 V DC

**V2:** Range -10 - +10 V DC

(Configurator software is used to change output over the described range of the selected suffix code. For changing out of this range, set the Output Range Selectors inside the unit before software adjustment.)

#### [3] POWER INPUT

AC Power

**M2:** 100 - 240 V AC (Operational voltage range 85 - 264 V, 47 - 66 Hz)

(90 - 264 V for UL)

DC Power

**R:** 24 V DC

(Operational voltage range 24 V ±10 %, ripple 10 %p-p max.)

**P:** 110 V DC

(Operational voltage range 85 - 150 V, ripple 10 %p-p max.)  
(110 V ±10 % for UL)

#### [4] OPTIONS (multiple selections)

Standards & Approvals (must be specified)

**/N:** Without CE or UL

**/CE:** CE marking

**/UL:** UL approval, CE marking

Other Options

**blank:** none

**/Q:** Option other than the above (specify the specification)

#### SPECIFICATIONS OF OPTION: Q (multiple selections)

COATING (For the detail, refer to our web site.)

**/C01:** Silicone coating

**/C02:** Polyurethane coating

**/C03:** Rubber coating (UL not available)

**/C04:** Polyolefin coating (UL not available)

TERMINAL SCREW MATERIAL

**/S01:** Stainless steel (UL not available)

#### RELATED PRODUCTS

- PC configurator software (model: JXCON)

Downloadable at our web site.

A dedicated cable is required to connect the module to the PC. Please refer to the internet software download site or the users manual for the PC configurator for applicable cable types.

## GENERAL SPECIFICATIONS

**Construction:** Plug-in  
**Connection:** M3 screw terminals (torque 0.8 N·m)  
**Screw terminal:** Chromated steel (standard) or stainless steel  
**Housing material:** Flame-resistant resin (black)  
**Isolation:** Input to output to power  
**Overrange output:** Approx. -15 to +115 %  
 (Negative current output is not provided.)  
**Manual zero adjustments:** -5 to +5 %  
 (factory setting: 0 %)  
**Manual span adjustments:** 95 to 105 %  
 (factory setting: 100 %)  
**Programming:** Downloaded from PC; input range, output range, zero and span, simulating output, etc.  
**Status indicator LED:** Blinking patterns indicate different operating status of the transmitter.  
**Configurator connection:** 2.5 dia. miniature jack; RS-232-C level

## INPUT SPECIFICATIONS

■ **DC Current:** Shunt resistor attached to the input terminals (0.5 W)  
**Operational range:** 0 – 70 mA DC with 100 Ω, 0.5 W  
**Input range:** 0 – 50 mA DC  
**Minimum span:** 2 mA  
**Offset:** Lower range can be any specific value within the input range provided that the minimum span is maintained.  
 If not specified, the input range is 4 – 20 mA DC.  
 ■ **DC Voltage**  
**Code S1 (narrow spans)**  
**Operational range:** -1.15 – +1.15 V DC  
**Input range:** -1 – +1 V DC  
**Minimum span:** 10 mV  
**Code S2 (wide spans)**  
**Operational range:** -11.5 – +11.5 V DC  
**Input range:** -10 – +10 V DC  
**Minimum span:** 100 mV  
**Offset:** Lower range can be any specific value within the input range provided that the minimum span is maintained.  
 If not specified, the input range is shown below.  
 S1: 0 – 100 mV DC  
 S2: 1 – 5 V DC

## OUTPUT SPECIFICATIONS

■ **DC Current**  
**Operational range:** 0 – 24 mA DC  
**Output range:** 0 – 20 mA DC  
**Minimum span:** 1 mA  
**Offset:** Lower range can be any specific value within the output range provided that the minimum span is

maintained.  
**Load resistance:** Output drive 15 V max.  
 (e.g. 4 – 20 mA: 750 Ω [15 V ÷ 20 mA])  
 If not specified, the output range is 4 – 20 mA DC.

■ **DC Voltage**  
**Code V1 (narrow spans)**  
**Operational range:** -3 – +3 V DC  
**Output range:** -2.5 – +2.5 V DC  
**Minimum span:** 250 mV  
**Code V2 (wide spans)**  
**Operational range:** -11.5 – +11.5 V DC  
**Output range:** -10 – +10 V DC  
**Minimum span:** 1 V  
**Offset:** Lower range can be any specific value within the output range provided that the minimum span is maintained.  
**Load resistance:** Output drive 1 mA max.  
 (e.g. 1 – 5 V: 5000 Ω [5 V ÷ 1 mA])  
 If not specified, the output range is shown below.  
 V1: 0 – 1 V DC  
 V2: 1 – 5 V DC

## INSTALLATION

**Power Consumption**  
 • **AC:**  
 Approx. 3 VA at 100 V  
 Approx. 4 VA at 200 V  
 Approx. 5 VA at 264 V  
 • **DC:** Approx. 2 W  
**Operating temperature:** -30 to +60°C (-22 to +140°F)  
**Operating humidity:** 30 to 90 %RH (non-condensing)  
**Mounting:** Surface or DIN rail  
**Weight:** 120 g (0.26 lb)

## PERFORMANCE in percentage of span

**Accuracy:** Input accuracy + output accuracy  
 Inversely proportional to the span.  
 Except the accuracy of input resistor.  
**Input accuracy:** (% of max. input range)  
 -1 – +1 V : ±0.01 %  
 -10 – +10 V : ±0.01 %  
 0 – 50 mA : ±0.02 %  
**Output accuracy:** ±0.04 % of max. output range  
 See CALCULATION EXAMPLES OF OVERALL ACURACY.  
**Temp. coefficient:** ±0.015 %/°C (±0.008 %/°F) of max. span at -5 to +55°C [23 to 131°F]  
**Response time:** ≤ 0.9 sec. (0 – 90 %)  
**Line voltage effect:** ±0.1 % over voltage range  
**Insulation resistance:** ≥ 100 MΩ with 500 V DC  
**Dielectric strength:** 2000 V AC @1 minute (input to output to power to ground)

## CALCULATION EXAMPLES OF OVERALL ACCURACY

[Example] Input Type -10 - +10 V, Input Range 1 - 5 V,  
 Output Type 0 - 20 mA, Output Range 4 - 20 mA  
 Max. Input Range (20 V) ÷ Span (4 V) × 0.01 % = 0.05 %  
 Max. Output Range (20 mA) ÷ Span (16 mA) × 0.04 %  
 = 0.05 %  
 Overall accuracy = 0.05 + 0.05 = ±0.10 %

## STANDARDS & APPROVALS

### EU conformity:

EMC Directive

EMI EN 61000-6-4

EMS EN 61000-6-2

Low Voltage Directive

EN 61010-1

Installation Category II

Pollution Degree 2

Input or output to power: Reinforced insulation (300 V)

Input to output: Basic insulation (300 V)

RoHS Directive

### Approval:

UL/C-UL nonincendive Class I, Division 2,

Groups A, B, C, and D

(ANSI/ISA-12.12.01, CAN/CSA-C22.2 No.213)

UL/C-UL general safety requirements

(UL 61010-1, CAN/CSA-C22.2 No.61010-1)

## EXTERNAL VIEW

### FRONT VIEW (with cover open)

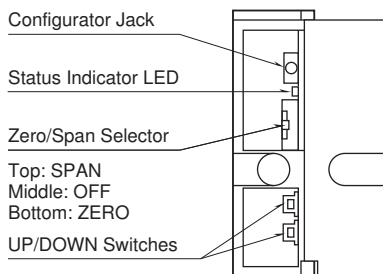

The front cover cannot be turned open by 180 deg. when there is no extra space between units.

### RIGHT SIDE VIEW

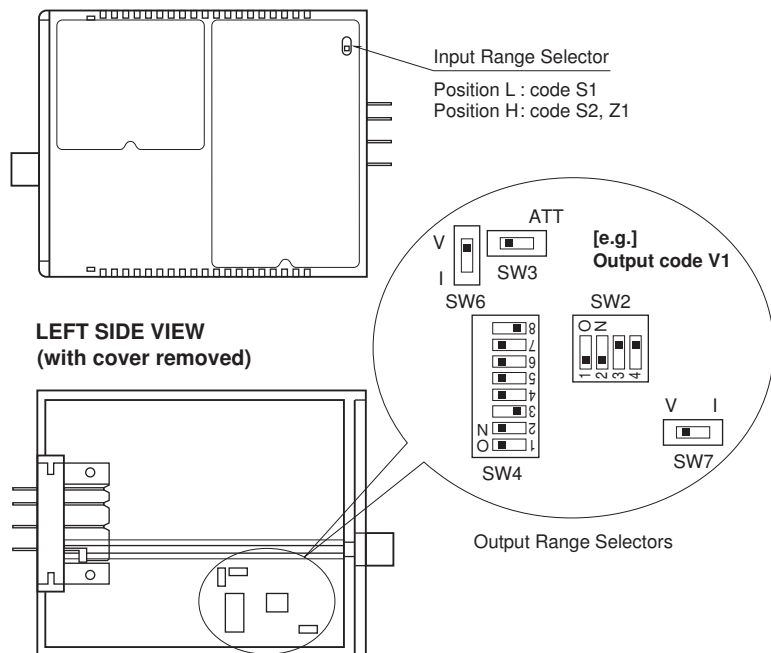

### LEFT SIDE VIEW (with cover removed)

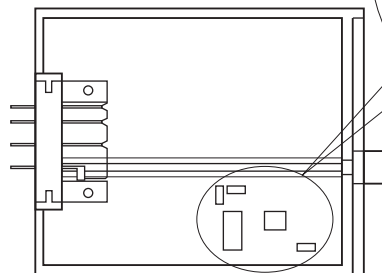

Refer to the instruction manual for detailed procedures.

## EXTERNAL DIMENSIONS unit: mm [inch]

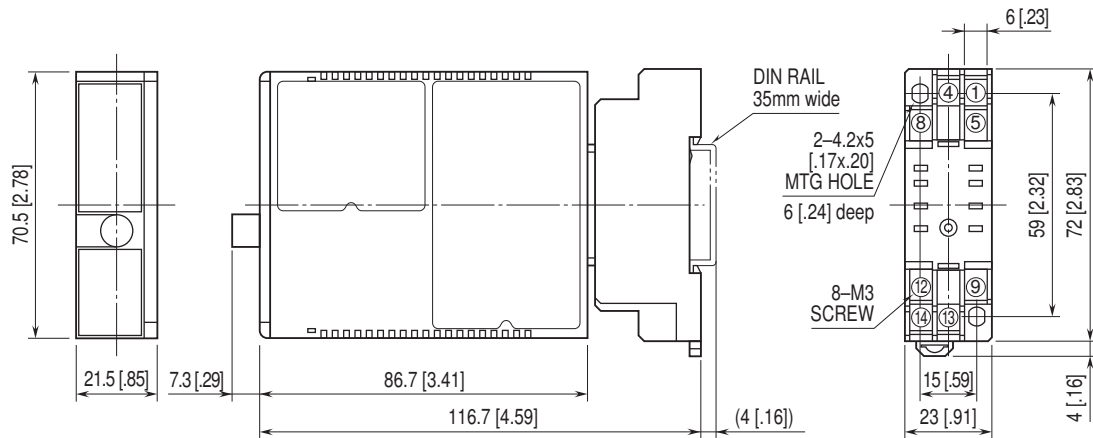

• When mounting, no extra space is needed between units.

## TERMINAL ASSIGNMENTS unit: mm [inch]

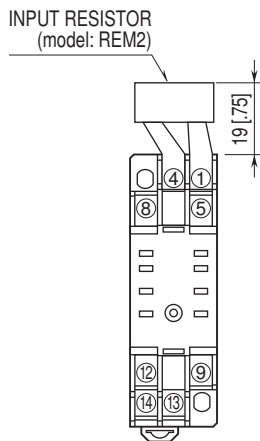

Input shunt resistor attached for current input.

## SCHEMATIC CIRCUITRY & CONNECTION DIAGRAM

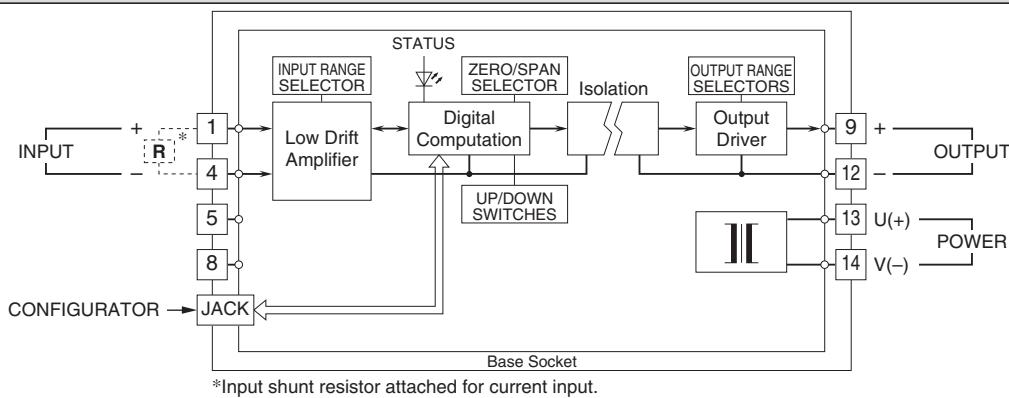

Specifications are subject to change without notice.