

Screw Terminal Ultra-Slim Signal Conditioners M6N Series

RTD ALARM

(PC programmable)

Functions & Features

- 7.5-mm wide ultra-slim design
- Low profile allows the M6N module mounted in a 120-mm deep panel
- PC programmable
- Linearization and upscale and downscale burnout protection
- High-density mounting
- Power and status indicator LEDs

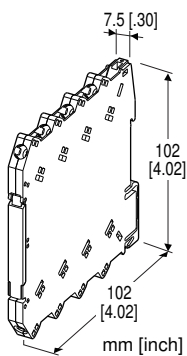

MODEL: M6NXAR-[1]-R[2]

ORDERING INFORMATION

- Code number: M6NXAR-[1]-R[2]

Specify a code from below for each of [1] and [2].

- (e.g. M6NXAR-4-R/Q)
- Temperature range (e.g. 0 - 100°C)
- Specify the specification for option code /Q (e.g. /C01)

[1] INPUT RTD

- 1:** JPt 100 (JIS'89)
(Usable range: -200 to +500°C, -328 to +932°F)
- 3:** Pt 100 (JIS'89)
(Usable range: -200 to +650°C, -328 to +1202°F)
- 4:** Pt 100 (JIS'97, IEC)
(Usable range: -200 to +850°C, -328 to +1562°F)
- 5:** Pt 50 Ω (JIS'81)
(Usable range: -200 to +649 °C, -328 to +1200°F)
- 7:** Pt 1000
(Usable range: -200 to +850°C, -328 to +1562°F)
- 9:** Cu 10 @25°C
(Usable range: -50 to +250°C, -58 to +482°F)

0: Specify (Please provide a resistance table.)
(Configurator software is used to change the input type and range. Input code 7: Pt 1000 cannot be switched to/from other input types while its temperature range can be changed.)

OUTPUT

Relay; SPDT or transfer contact

POWER INPUT

DC Power

R: 24 V DC

(Operational voltage range 24 V ±10 %, ripple 10 %p-p max.)

[2] OPTIONS

blank: none

/Q: With options (specify the specification)

SPECIFICATIONS OF OPTION: Q

COATING (For the detail, refer to our web site.)

/C01: Silicone coating

/C02: Polyurethane coating

RELATED PRODUCTS

- PC configurator software (model: M6CFG)

Downloadable at our web site.

A dedicated cable is required to connect the module to the PC. Please refer to the internet software download site or the users manual for the PC configurator for applicable cable types.

GENERAL SPECIFICATIONS

Connection

Input and output: M3 screw terminal (torque 0.5 N·m)

Power input: Via the Installation Base (model: M6NBS) or M3 screw terminal (torque 0.5 N·m)

Recommended solderless terminal: Max. 5.8 mm (0.23") wide; Ones with insulation sleeve do not fit.

Applicable wire size: 0.2 - 2.5 mm²

Housing material: Flame-resistant resin (black)

Isolation: Input to output to power

Burnout: Upscale standard; downscale or no burnout optional by programming

In case of upscale standard, the alarm operates as if the input signal has exceeded over the range.

Linearization: Standard

Power indicator LED: Green LED turns on when the power is supplied.

Status indicator LED: Orange LED; Blinking patterns indicate different operating status of the transmitter.

Alarm monitor LED: Red LED turns on when the alarm is tripped.

Programming: Downloaded from PC

Input type and range

Input fine adjustments

User's RTD table (max. 300 points)

Burnout (Upscale, downscale or no burnout)

Alarm setpoint (input %)

Trip action (High or Low)

Relay coil (energized or de-energized)

Power ON delay time (0 to 999 sec.)

Alarm ON delay time (0 to 999 sec.)

Hysteresis (deadband) (input %)

Alarm test, and others

Configurator connection: 2.5 dia. miniature jack;

RS-232-C level

Factory default setting

Alarm setpoint: 80%

Trip action: High

Relay coil at alarm: Energized

Power ON delay time: 5 seconds

Alarm ON delay time: 0 seconds

Hysteresis (deadband): 1.0%

Burnout: Upscale

■ Recommended solderless terminal (unit: mm [inch])

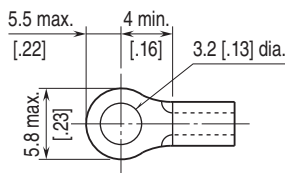

INPUT SPECIFICATIONS

Input: 2- or 3-wire RTD

Maximum leadwire resistance: 10 Ω per wire

Sensing current: ≤ 1.5 mA (≤ 0.15 mA for Pt 1000)

Minimum span: 20°C or 36°F

Resistance range:

0 - 500 Ω (Input code: 1, 3, 4, 5, 9)

0 - 5 kΩ (Input code: 7)

If not specified, the input range is 0 - 100°C.

OUTPUT SPECIFICATIONS

■ **Relay Output**

Relay rating:

250 V AC @2 A (cos φ = 1)

30 V DC @2 A (resistive load)

Maximum switching voltage: 250 V AC or 125 V DC

Maximum switching power: 500 VA or 60 W

Minimum load: 5 V DC @100 mA

Mechanical life: 5 × 10⁵ cycles (rate 180/min.)

Alarm Trip Operation Terminal No. in parentheses

• **Setting Example**

Hi alarm (coil energized at alarm) or
Lo alarm (coil de-energized at alarm)

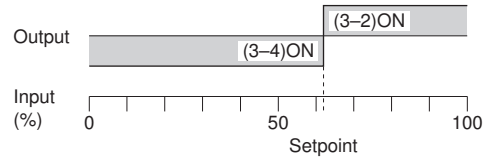

Trip operation in power failure: Terminals 3 – 4 turn ON.

INSTALLATION

Power consumption: Approx. 0.5 W

Operating temperature: -20 to +55°C (-4 to +131°F)

Operating humidity: 30 to 90 %RH (non-condensing)

Mounting: Installation Base (model: M6NBS) or DIN rail

Weight: 65 g (2.3 oz)

PERFORMANCE in percentage of span

Setpoint accuracy (trip point accuracy)

Pt and JPt: Whichever greater ±0.1 % of input range or ±0.15°C

Cu10: ±1°C

Temp. coefficient: ±0.01 %/°C (±0.006 %/°F) of max. span

Response time: ≤ 1 sec. (0 - 100 % at 90 % setpoint)

Burnout response time: ≤ 1 sec.

Line voltage effect: ±0.1 % over voltage range

Insulation resistance: ≥ 100 MΩ with 500 V DC

Dielectric strength: 2000 V AC @1 minute (input to output to power to ground)

CALCULATION EXAMPLES OF SETPOINT ACCURACY

[Example] Input type Pt 100, Input range 0 - 100°C

Setpoint accuracy^{*1} (0.15°C^{*2}) ÷ Span (100°C) × 100 %

*1. Calculate the accuracy in °C

*2. 100 °C × 0.1 % = 0.1 °C ≤ 0.15 °C. 0.15 °C is used as input accuracy value.

STANDARDS & APPROVALS

EU conformity:

EMC Directive

EMI EN 61000-6-4

EMS EN 61000-6-2

Low Voltage Directive

EN 61010-1

Measurement Category II (output)

Pollution Degree 2

Input or power to output: Reinforced insulation (300 V)

RoHS Directive

EXTERNAL VIEW

(With the cover open)

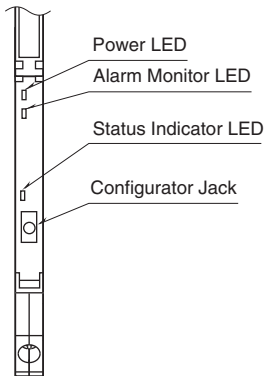

EXTERNAL DIMENSIONS & TERMINAL ASSIGNMENTS unit: mm [inch]

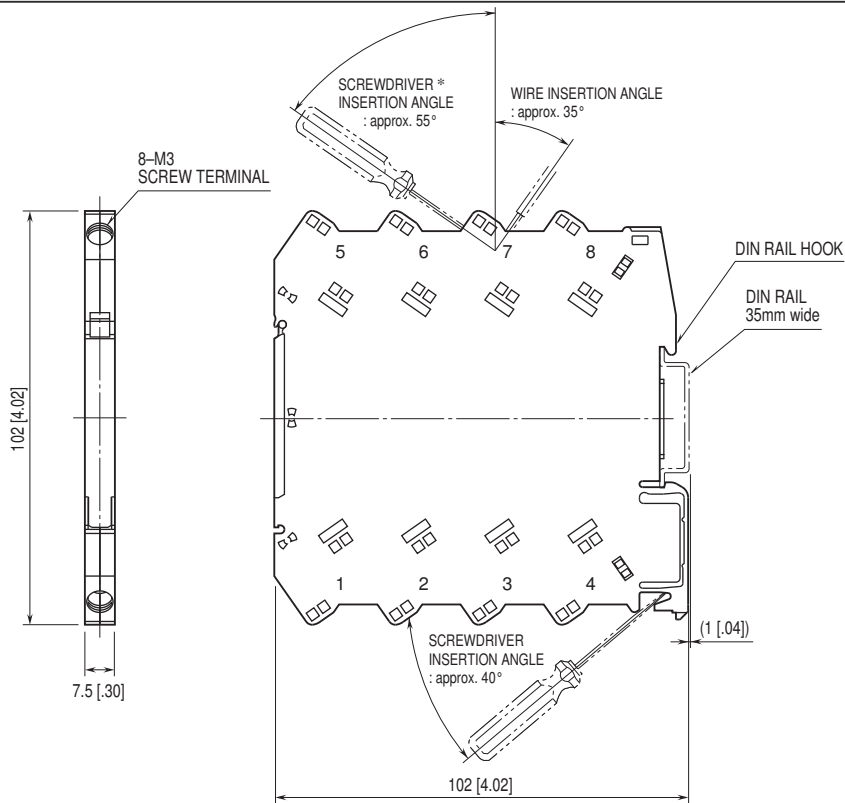

*Screwdriver stem diameter: 6 mm [.24"] or less

• When mounting, no extra space is needed between units.

SCHEMATIC CIRCUITRY & CONNECTION DIAGRAM

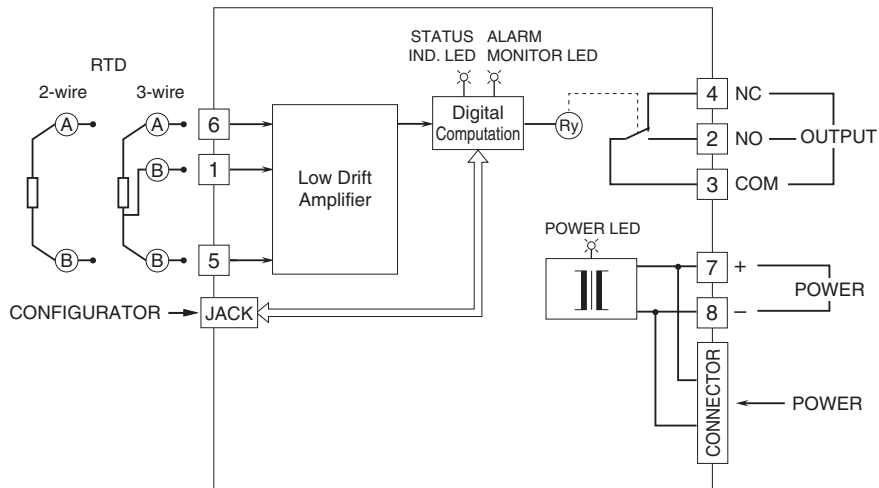

■ Relay Protection • AC Powered

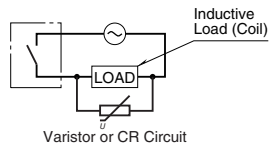

• DC Powered

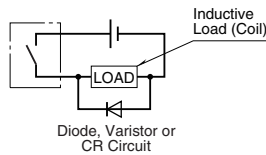

Specifications are subject to change without notice.