

Dual Output Super-mini Signal Conditioners Pico-M Series

PULSE ISOLATOR

(built-in excitation, CE)

Functions & Features

- Amplifying, waveshaping a pulse rate input and providing two galvanically isolated pulse signals
- Space-saving, easy-to-maintain, multi-channel installation base

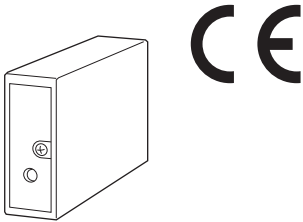

MODEL: M8PP1-[1][2][3][4]-R[5]

ORDERING INFORMATION

- Code number: M8PP1-[1][2][3][4]-R[5]
Specify a code from below for each of [1] through [5].
(e.g. M8PP1-B7A1A12-R/Q)
- Output pulse width (e.g. 75 msec.)
Use Ordering In-formation Sheet (No. ESU-5484) for Input Codes B:DC voltage pulse or E: AC voltage pulse, or for non-standard output pulse width.
- Specify the specification for option code /Q
(e.g. /C01)

[1] INPUT

- A:** Dry contact
- B:** DC voltage pulse (Specify sensitivity)
- C:** 5 V pulse (sensitivity 2 V)
- D:** 12 V/24 V pulse (sensitivity 5 V)
- E:** AC voltage pulse (Specify sensitivity)
- H:** Two-wire current pulse

[2] EXCITATION

- 0:** None
- 4:** 12 V DC / 30 mA
- 7:** 24 V DC / 30 mA

[3] OUTPUT 1 / OUTPUT 2

- A1A1:** Open collector / open collector (max. 100 kHz)
- A2A2:** Open collector / open collector (max. 10 Hz)
- M1M1:** 5 V pulse / 5 V pulse (max. 100 kHz)
- M2M2:** 5 V pulse / 5 V pulse (max. 10 Hz)
Max. 50 kHz for AC voltage pulse input

[4] OUTPUT PULSE WIDTH

- 1:** Equal to the input
- 2:** One-shot output (std. pulse width 50 msec.)
Specify when optional pulse width is required.

POWER INPUT

- DC Power**
- R:** 24 V DC
(Operational voltage range 24 V \pm 10 %, ripple 10 %p-p max.)

[5] OPTIONS

- blank:** none
- /Q:** With options (specify the specification)

SPECIFICATIONS OF OPTION: Q

- COATING** (For the detail, refer to our web site.)
- /C01:** Silicone coating
- /C02:** Polyurethane coating
- /C03:** Rubber coating

RELATED PRODUCTS

- Installation Base or Single Mount Base Socket (model: M8BSx)
This unit must be mounted on dedicated base or socket except Model M8BS2 base.

GENERAL SPECIFICATIONS

- Construction:** Plug-in
- Mounting screw:** M3 screw (torque 0.3 N·m)
- Housing material:** Flame-resistant resin (black)
- Power supply:** Via the Installation Base terminals (model: M8BSx)
- Isolation:** Input to output 1 to output 2 to power
- Polarity switch:** Inverting output pulse logic (factory setting: non-inverted)
- Input pulse sensing:** DC coupled (AC coupled for AC voltage pulse)

INPUT SPECIFICATIONS

- Excitation:** 12 V DC \pm 2 V @30 mA
24 V DC \pm 4 V @30 mA
shortcircuit protection; approx. \leq 5 mA at shortcircuit
- Caution:** With a current exceeding 30 mA, the pulse isolator stops feeding the sensor excitation, until the sensor is removed and connected again.
- Pulse width time requirement**
- No pulse width adj. for output:** 2 μ sec. min.
(10 msec. min. for 0 - 10 Hz)
- One-shot:** 1 msec. min.

■ Dry Contact

Max. frequency: 100 kHz

Sensing: Approx. 12 V DC @3 mA

ON/OFF level: $\geq 4 \text{ k}\Omega/6 \text{ V}$ at OFF

$\leq 1.3 \text{ k}\Omega/4 \text{ V}$ at ON

■ **DC Voltage Pulse:** Specify detecting level, amplitude and DC offset.

Max. frequency: 100 kHz

Waveform: Square or sine

Input impedance: 30 k Ω min.

Input amplitude: 2 - 50 V p-p

Detecting level: 2 - 10 V; $0.6 \text{ V} \leq V_H - V_L \leq 1.3 \text{ V}$

Max. voltage between input terminals: 50 V

• 5 V, 12 V, 24 V Pulse

Max. frequency: 100 kHz

Waveform: Square or sine

Input impedance: 30 k Ω min.

Detecting H level

5 V pulse: $\geq 3 \text{ V}$

12 V, 24 V pulse: $\geq 6 \text{ V}$

Detecting L level

5 V pulse: $\leq 1 \text{ V}$

12 V, 24 V pulse: $\leq 4 \text{ V}$

■ **AC Voltage Pulse:** Specify amplitude and frequency.

Max. frequency: 50 kHz

Min. frequency: 1 Hz

Waveform: Sine

Input impedance: 10 k Ω min.

Input amplitude: 0.1 - 100 V p-p

Max. voltage between input terminals: 50 V

■ **Two-wire Current Pulse**

Max. frequency: 100 kHz

Input resistance: Receiving resistor 250 Ω

Input range: 0 - 25 mA

Detecting level: $\leq 4 \text{ mA}$ for Lo, $\geq 12 \text{ mA}$ for Hi

■ Pulse

• DC Voltage Pulse

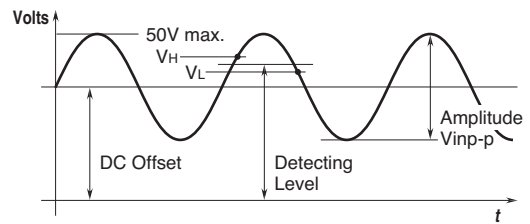

• AC Voltage Pulse

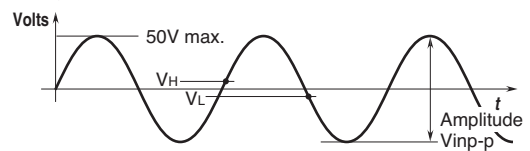

• Two-wire Current Pulse

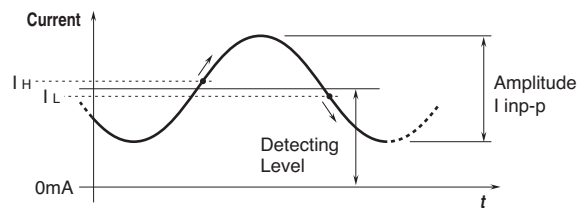

OUTPUT SPECIFICATIONS

Max. frequency: 100 kHz

■ **Open Collector:** 50 V DC @50 mA

Saturation voltage: 0.5 V DC

■ **5 V Pulse**

Hi level: $5 \text{ V} \pm 10 \%$

Lo level: $\leq 0.5 \text{ V}$

Load resistance: 1000 Ω min.

OUTPUT PULSE WIDTH

• **One-shot Output:** Constant pulse width

Output Frequency (Hz) = $500 \div$ Output Pulse Width (msec.)

Pulse width: 1 - 500 msec. (standard 50 msec. $\pm 20 \%$)

INSTALLATION

Current consumption: Approx. 90 mA

Operating temperature: 0 to 55°C (32 to 131°F)

Operating humidity: 30 to 95 %RH (non-condensing)

Mounting: Installation Base (model: M8BSx)

Weight: 70 g (2.5 oz)

PERFORMANCE

Insulation resistance: $\geq 100 \text{ M}\Omega$ with 500 V DC

Dielectric strength:

1500 V AC @1 minute (input to output 1 or output 2 or power to ground)

500 V AC @1 minute (output 1 to output 2 to power)

SWC test: ANSI/IEEE-C37.90.1-1989

STANDARDS & APPROVALS

EU conformity:

EMC Directive

EMI EN 61000-6-4

EMS EN 61000-6-2

RoHS Directive

FRONT VIEW

• Polarity SW

Used to select output pulse logic.

Push in the switch to invert the output logic.

Push back for non-inverted output.

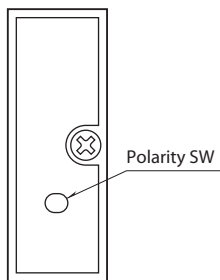

OUTPUT LOGIC

INPUT TYPE	PULSE LOGIC	INPUT	VOLTAGE PULSE OUTPUT	OPEN COLLECTOR
DC Voltage Pulse Input 2-wire Current Pulse Input [ON current (H) OFF current (L)]	Non Inverted	H L	H L	OFF ON
	Inverted	H L	H L	OFF ON
Dry Contact Input	Non Inverted	OFF ON	H L	OFF ON
	Inverted	OFF ON	H L	OFF ON
AC Voltage Pulse	Non Inverted		H L	OFF ON
	Inverted		H L	OFF ON

The pulse width in one-shot means the bold lined section of a pulse waveform.

EXTERNAL DIMENSIONS unit: mm [inch]

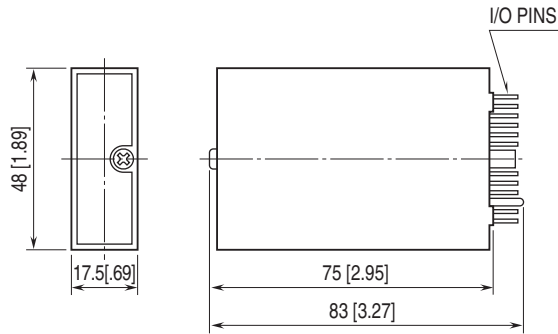

SCHEMATIC CIRCUITRY & CONNECTION DIAGRAM

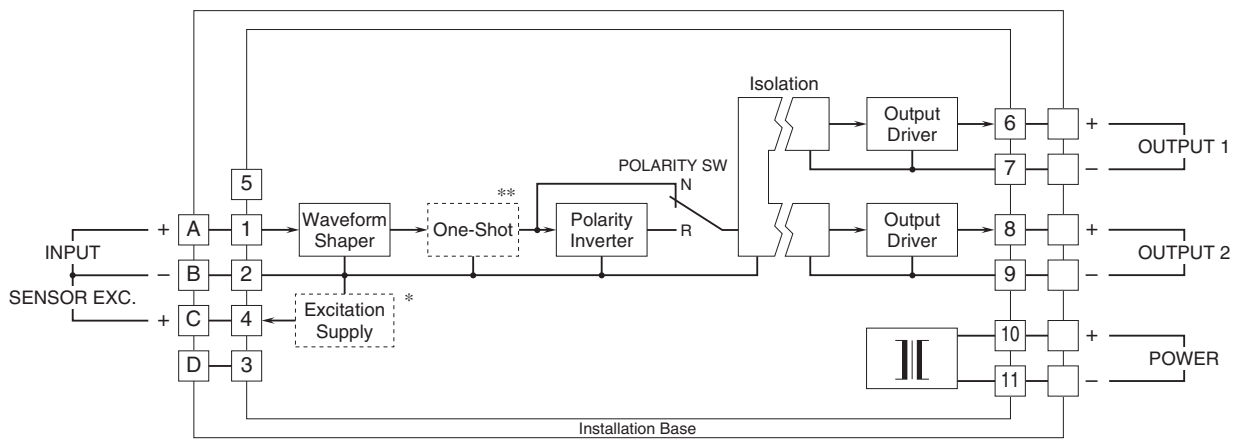

* Provided only when the sensor excitation option is selected.
 ** Provided only when the one-shot output option is selected.

Input Connection Examples

■ Dry Contact

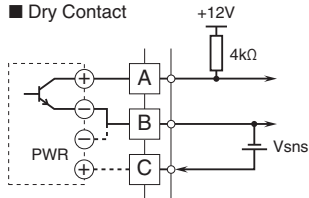

■ DC Voltage Pulse

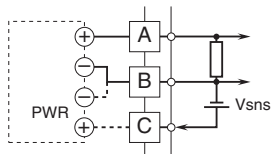

■ AC Voltage Pulse

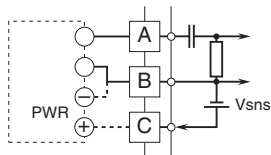

■ 2-Wire Current Pulse

• Built-in Excitation

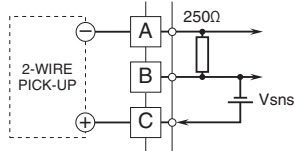

• External DC Supply

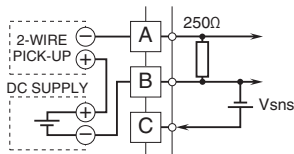

Output Connection Examples

■ Open Collector

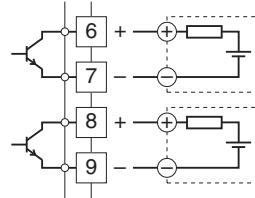

■ Voltage Pulse

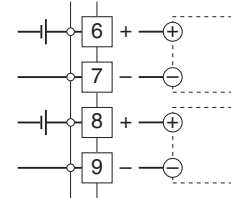



Specifications are subject to change without notice.