

Remote I/O R3 Series

ENCODER INPUT MODULE

(RS-422 input; alarm output)

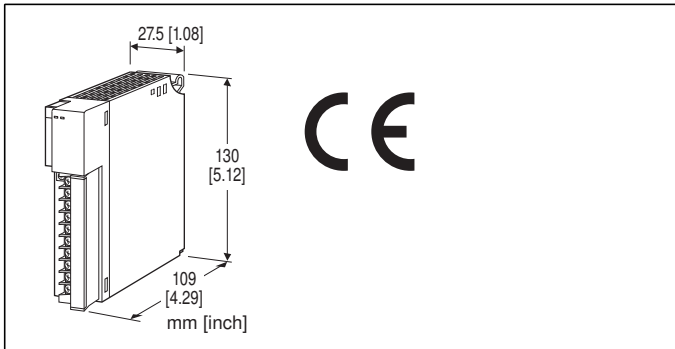

MODEL: R3-PA2[1][2]

ORDERING INFORMATION

- Code number: R3-PA2[1][2]
- Specify a code from below for each of [1] and [2].
(e.g. R3-PA2W/CE/Q)
- Specify the specification for option code /Q
(e.g. /C01/SET)

NO. OF CHANNELS

2: 2

[1] COMMUNICATION MODE

S: Single

W: Dual

[2] OPTIONS (multiple selections)

Standards & Approvals

blank: Without CE

/CE: CE marking

Other Options

blank: none

/Q: Option other than the above (specify the specification)

SPECIFICATIONS OF OPTION: Q (multiple selections)

COATING (For the detail, refer to our web site.)

/C01: Silicone coating

/C02: Polyurethane coating

/C03: Rubber coating

EX-FACTORY SETTING

/SET: Preset according to the Ordering Information Sheet

(No. ESU-8386)

GENERAL SPECIFICATIONS

Connection

Internal bus: Via the Installation Base (model: R3-BSx)

Input, Output: M3 separable screw terminal
(torque 0.5 N·m)

Internal power: Via the Installation Base (model: R3-BSx)

Screw terminal: Nickel-plated steel

Isolation: Input 1 to input 2 to internal bus or internal power

Alarm output: Two outputs per channel available; setpoints are programmable for the speed or the position data by using the R3CON PC Configurator software.

DIP switch settings:

- Input range
- Count Mode
- Alarm Contact Form
- Start Count

(Refer to the instruction manual)

RUN indicator: Bi-color (red/green) LED;

Red when the bus A operates normally;

Green when the bus B operates normally;

Amber when both buses operate normally.

ERR indicator: Green LED turns on in normal operating conditions.

Low-end cutout: 0.1 %

Reset input: Position data reset to '0' when the external contact is closed. (Reset count can be changed using the R3CON PC Configurator software.)

INPUT SPECIFICATIONS

Input: RS-422 line driver, two-phase pulse (Up/down count is not performed correctly by either phase A or phase B input)

■ ENCODER PULSE INPUT

Input range: 0 - 100 kHz, 0 - 10 kHz, 0 - 1 kHz, 0 - 100 Hz, 0 - 10 Hz, 0 - 1 Hz, 0 - 0.1 Hz

Minimum pulse width requirement: 5 μsec. for both ON and OFF

■ Reset Input (contact input)

Number of input: 1 contact per input (2 in total)

Isolation: Optical isolator + transformer (internal excitation supply)

Input resistance: Approx. 5.9 kΩ

Common: Negative (2 terminals)

Sensing voltage: 13 V DC (max. 24 V with no load)

ON current/voltage: ≥ 1.5 mA (≥ 9V)

OFF current/voltage: ≤ 0.75 mA (≤ 4.5V)

OUTPUT SPECIFICATIONS

■ALARM OUTPUT (open collector)

Number of input: 2 contacts per input (4 in total)

Isolation: Optical isolator

Rated load voltage: 24 V DC $\pm 10\%$

Max. load current: 0.1 A per point

Max. rush current: 0.5 A, ≤ 10 msec.

Leakage current at OFF: ≤ 0.1 mA

Max. voltage drop at ON: 0.6 V DC typical, 1.2 V DC maximum

Common: Negative (2 terminals)

Common current: Max. 16 A per common

INSTALLATION

Operating temperature: -10 to +55°C (14 to 131°F)

Operating humidity: 30 to 90 %RH (non-condensing)

Atmosphere: No corrosive gas or heavy dust

Mounting: Installation Base (model: R3-BSx)

Weight: 200 g (0.44 lb)

PERFORMANCE

Speed conversion accuracy: $\pm 0.1\%$

Speed data range: 0 - 10000 of the input range

Position data range: -100 000 000 to +100 000 000

Data allocation: 8

Current consumption: 80 mA

Temp. coefficient: $\pm 0.015\%/^{\circ}\text{C}$ ($\pm 0.008\%/^{\circ}\text{F}$)

Insulation resistance: $\geq 100\text{ M}\Omega$ with 500 V DC

Dielectric strength: 1500 V AC @ 1 minute (input 1 to input 2 to internal bus or internal power)

2000 V AC @ 1 minute (power input to FG; isolated on the power supply module)

STANDARDS & APPROVALS

EU conformity:

EMC Directive

EMI EN 61000-6-4

EMS EN 61000-6-2

RoHS Directive

EXTERNAL VIEW

FRONT VIEW

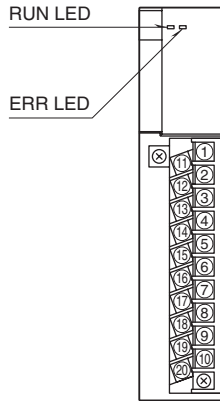

SIDE VIEW

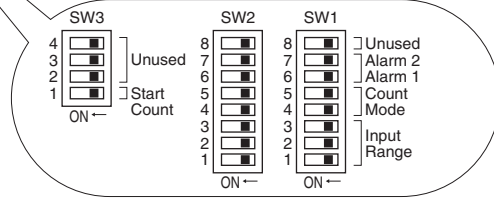
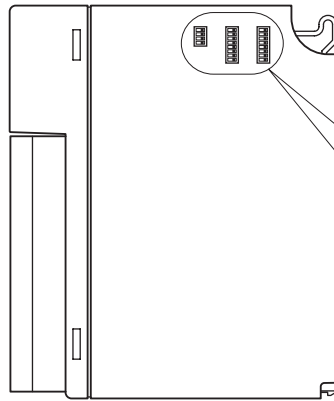

I/O DATA DESCRIPTIONS

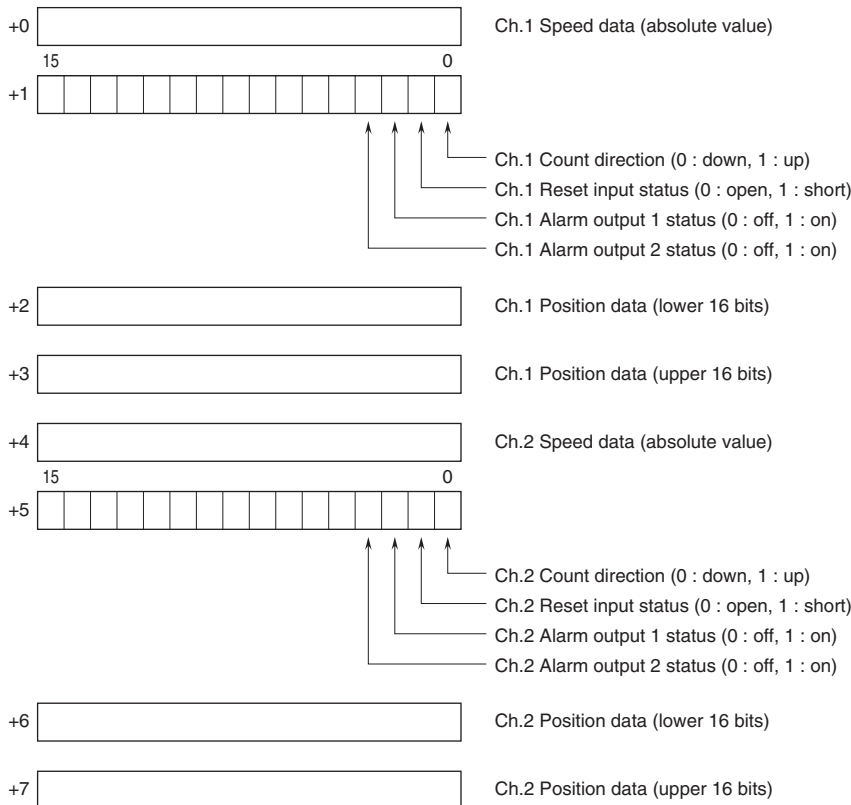

EXTERNAL DIMENSIONS & TERMINAL ASSIGNMENTS unit: mm [inch]

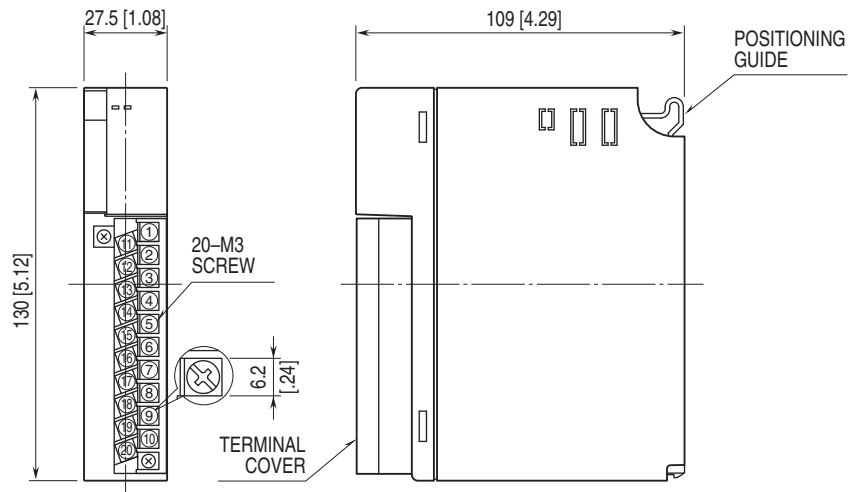

SCHEMATIC CIRCUITRY & CONNECTION DIAGRAM

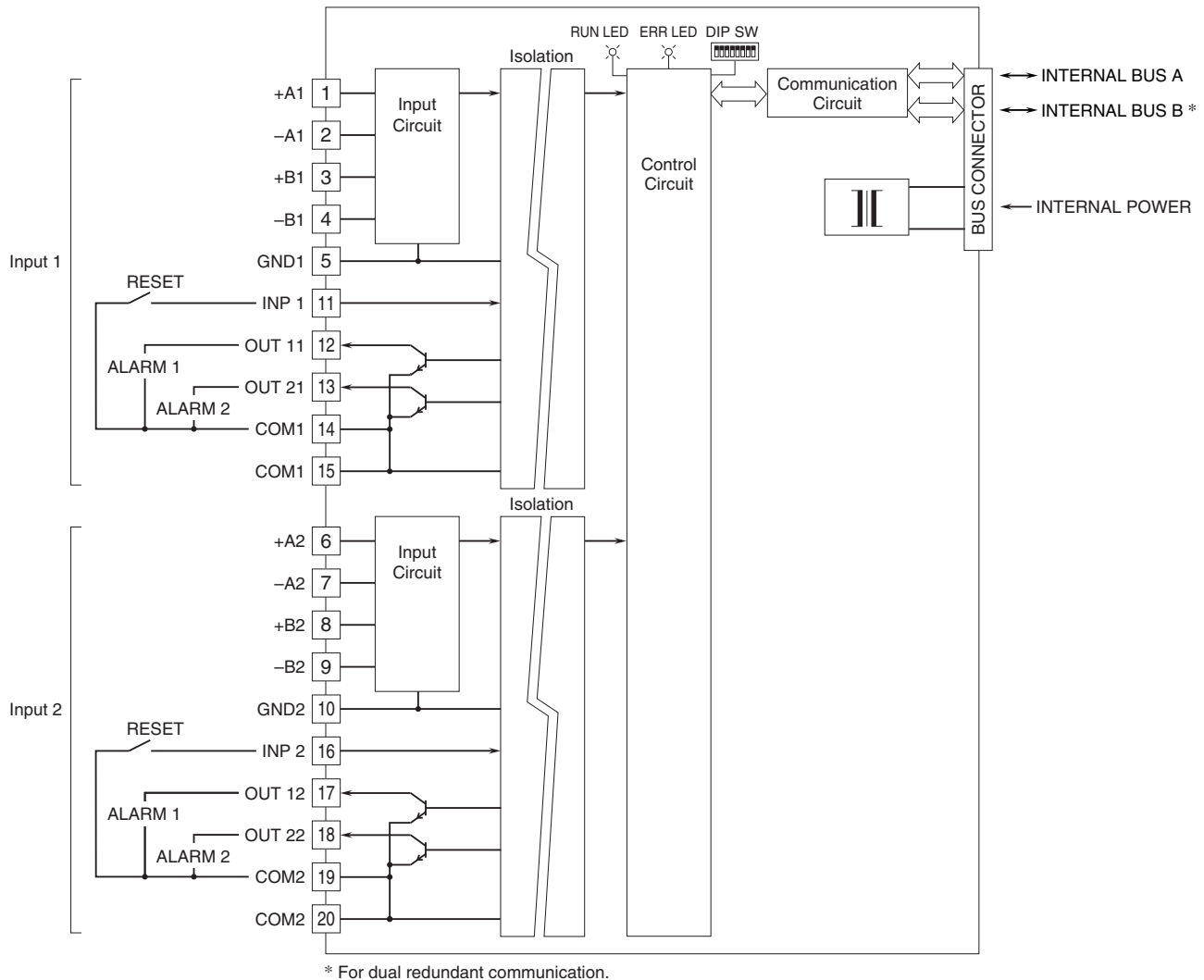



Specifications are subject to change without notice.