

Remote I/O R3 Series

LOW SPEED TOTALIZED PULSE INPUT MODULE

(4 points, isolated)

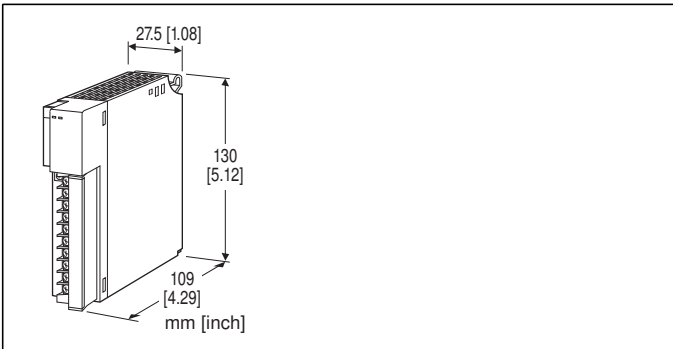

MODEL: R3-PA4B[1][2]

ORDERING INFORMATION

- Code number: R3-PA4B[1][2]
- Specify a code from below for each of [1] and [2].
(e.g. R3-PA4BW/Q)
- Specify the specification for option code /Q
(e.g. /C01/SET)

NO. OF CHANNELS

4B: 4 channels, low speed totalized pulse input

[1] COMMUNICATION MODE

S: Single

W: Dual

[2] OPTIONS

blank: none

/Q: With options (specify the specification)

SPECIFICATIONS OF OPTION: Q (multiple selections)

COATING (For the detail, refer to our web site.)

/C01: Silicone coating

/C02: Polyurethane coating

/C03: Rubber coating

EX-FACTORY SETTING

/SET: Preset according to the Ordering Information Sheet
(No. ESU-8387)

GENERAL SPECIFICATIONS

Connection

Internal bus: Via the Installation Base (model: R3-BSx)

Input: M3 separable screw terminal (torque 0.5 N·m)

Internal power: Via the Installation Base (model: R3-BSx)

Screw terminal: Nickel-plated steel

Isolation: Input 1 to input 2 to input 3 to input 4 to internal bus or internal power

Input gain: Selectable with the side DIP SW

RUN indicator: Bi-color (red/green) LED;

Red when the bus A operates normally;

Green when the bus B operates normally;

Amber when both buses operate normally.

ERR indicator: Bi-color (red/green) LED;

Red with input abnormality;

Green in normal operating conditions.

Count reset: Via DIP switches on the side

INPUT SPECIFICATIONS

■ Sensor Excitation

Voltage: 12 V DC $\pm 10\%$

Current: 15 mA

Current limiting circuit: Approx. 30 mA

■ MAXIMUM FREQUENCY: 100 Hz

Minimum pulse width requirement: 5 msec. for both ON and OFF

■ DIVIDING RATIO: 1 - 50000 (programmable using the R3CON PC Configurator software; factory setting '1')

■ COUNT RANGE: 1 - 100 000 000 (0 at reset)

Min. and max. pulse range selectable using the R3CON PC Configurator Software. Refer to the R3CON Users Manual for detailed information.

Count at overflow: Reset and restart at '1.'

Recount start value at over flow: 0 or 1

Maximum count: 1000 - 800 000 000

■ DETECTING LEVEL

Detecting level: 15 - 100 %

(of voltage across the terminals)

Factory setting: 50 % (programmable using the R3CON PC Configurator software)

Current limiting circuit: Approx. 30 mA

Note 1. Each channel has three sets of input terminals.

Input terminal 1: 2 - 5, 7 - 10, 12 - 15, 17 - 20

Input terminal 2: 3 - 5, 8 - 10, 13 - 15, 18 - 20

Input terminal 3: 4 - 5, 9 - 10, 14 - 15, 19 - 20

Note 2. Gain 1 or Gain 2 selectable with the side DIP SW.

Note 3. Measured as 0 % below 15 % of the range.

■ THRESHOLD

Pulse logic is detected by comparing input pulse voltage and the detecting level. Detecting 'Rise' or 'Sink' can be switched by using the R3CON PC Configurator software; factory setting 'Rise')

■ Open Collector (input terminal 3, gain 1)

Sensor excitation: 12 V DC

Pull-up resistance: 20 k Ω (shorted across 1 - 3, 6 - 8, 11 -

13, 16 - 18 respectively)

ON voltage: ≤ 1.5 V (≤ 2 k Ω recommended)

OFF voltage: ≥ 2.5 V (≥ 20 k Ω recommended)

(Set detecting level 50 % when the saturation voltage is not greater than 0.8 V, set 70 % when the saturation voltage is between 0.8 to 1.5 V.)

■ **Voltage Pulse** (input terminals 1 and 2)

Waveform: Square, sine or similar waveforms

Input impedance: 100 k Ω minimum at input terminal 1

20 k Ω minimum at input terminal 2

Operational voltage across the terminals:

0 - 50 V (input terminal 1, gain 1)

0 - 25 V (input terminal 1, gain 2)

0 - 12 V (input terminal 2, gain 1)

0 - 6 V (input terminal 2, gain 2)

procedure because the module does not start counting with ON state.

INSTALLATION

Operating temperature: -10 to +55°C (14 to 131°F)

Operating humidity: 30 to 90 %RH (non-condensing)

Atmosphere: No corrosive gas or heavy dust

Mounting: Installation Base (model: R3-BSx)

Weight: 200 g (0.44 lb)

PERFORMANCE

Data allocation: 8

Current consumption:

80 mA (with no load at the sensor excitation)

130 mA (15 mA at each excitation)

Insulation resistance: ≥ 100 M Ω with 500 V DC

Dielectric strength: 1500 V AC @ 1 minute (input 1 to input 2 to input 3 to input 4 to internal bus or internal power)

2000 V AC @ 1 minute (power input to FG; isolated on the power supply module)

FUNCTIONS

■ **MANUAL COUNT RESET**

- 1) Remove Network Module or its cables and interrupt communication with other devices.
- 2) Turn ON the Count Reset SW.
- 3) Return the module to the base and turn the power supply on.
- 4) ERR LED turns on and the module starts resetting its counter. When the resetting is complete, the LED turns to green. DO NOT remove the power while the red LED is on. The RUN LED starts blinking at the same time.
- 5) After the green LED is confirmed, turn the power supply off.
- 6) Turn OFF the Count Reset SW.
- 7) Return the Network module onto the base and turn the power supply on.

Note: Count Reset SW must be turned OFF after this

EXTERNAL VIEW

■FRONT VIEW

■SIDE VIEW

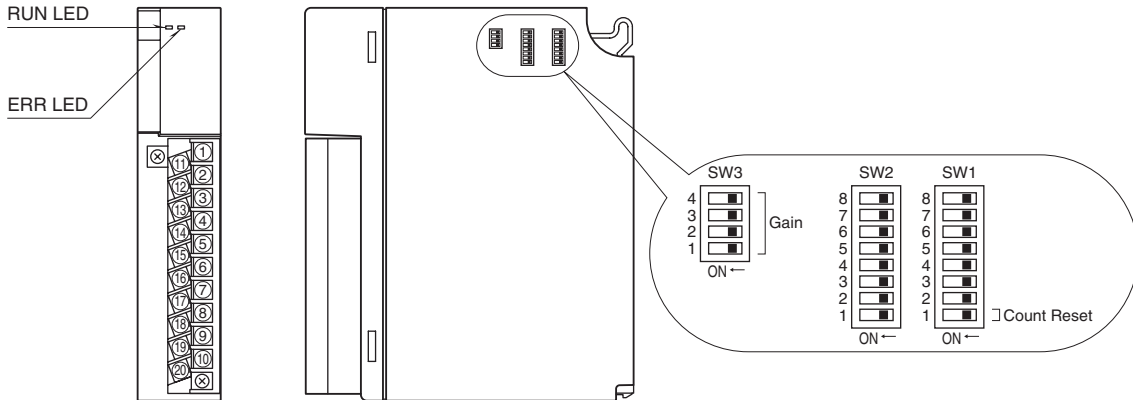

Set the Count Reset SW to OFF to start counting.

OUTPUT DATA DESCRIPTIONS

ADDRESS	CONTENTS
+0	Input 1 totalized value (lower 16 bits)
+1	Input 1 totalized value (upper 16 bits)
+2	Input 2 totalized value (lower 16 bits)
+3	Input 2 totalized value (upper 16 bits)
+4	Input 3 totalized value (lower 16 bits)
+5	Input 3 totalized value (upper 16 bits)
+6	Input 4 totalized value (lower 16 bits)
+7	Input 4 totalized value (upper 16 bits)

EXTERNAL DIMENSIONS & TERMINAL ASSIGNMENTS unit: mm [inch]

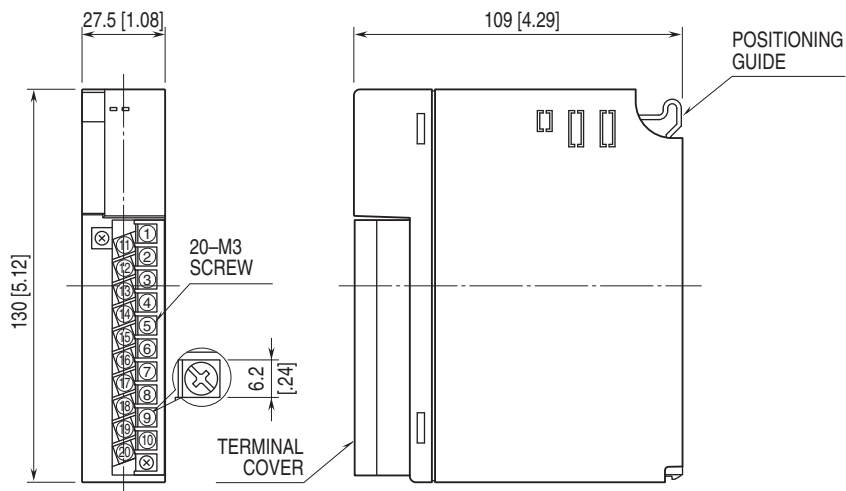

SCHEMATIC CIRCUITRY & CONNECTION DIAGRAM

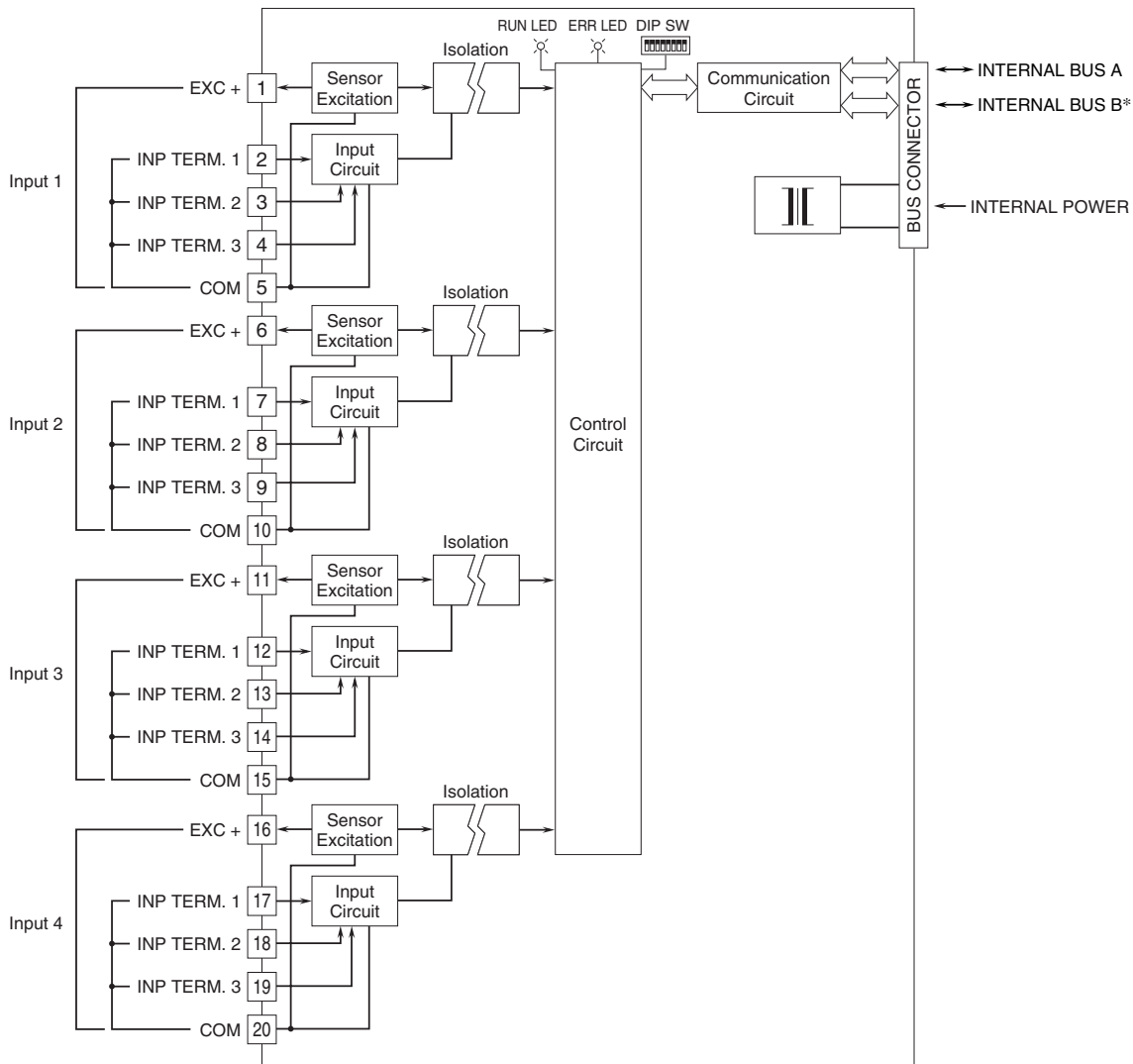

*For dual redundant communication.

Input Connection Example (Input 1)

■ Open Collector

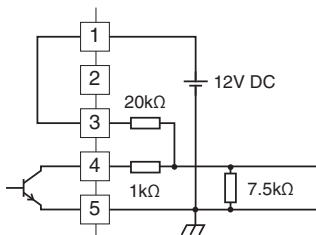

■ Voltage Pulse input

• Operational voltage across the terminals: 0 – 50V, 0 – 25V

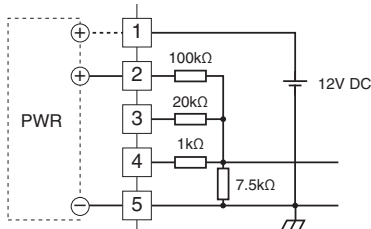

• Operational voltage across the terminals: 0 – 12V, 0 – 6V

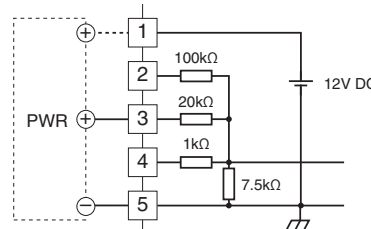



Specifications are subject to change without notice.