

Remote I/O R30 Series

NETWORK MODULE

(CC-Link IE TSN)

Functions & Features

- Interchanges analog or discrete I/O signals with the fieldbus (CC-Link IE TSN)
- Combined with R3 Series I/O modules

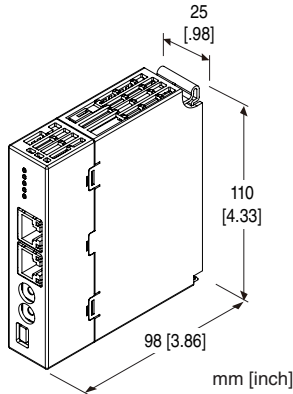

CE
CC-Link IE TSN

MODEL: R30NCIT1[1]

ORDERING INFORMATION

- Code number: R30NCIT1[1]
Specify a code from below for [1].
(e.g. R30NCIT1/Q)
- Specify the specification for option code /Q
(e.g. /C01)

[1] OPTIONS

blank: none

/Q: With options (specify the specification)

SPECIFICATIONS OF OPTION: Q

COATING (For the detail, refer to our web site.)

/C01: Silicone coating

/C02: Polyurethane coating

/C03: Rubber coating

RELATED PRODUCTS

- PC configurator software (model: R30CFG)
- PC configurator software (model: R3CON)
- CSP+ file

The configurator software and CSP+ file are downloadable at our web site.

CSP+ file is also downloadable at CC-Link Partner Association's web site.

For connecting to PC, use commercially available Mini-B type USB cable. (provided by user)

- R3 series I/O modules (except R3-TC2 and R3S-CM2A)

GENERAL SPECIFICATIONS

Connection

CC-Link IE TSN: RJ-45 connector

Internal bus: Via the Installation Base (model: R30BS)

Internal power: Via the Installation Base (model: R30BS)

Isolation: CC-Link IE TSN to internal bus or internal power

Input type & range:

R30 series I/O module: PC configuration software (model: R30CFG)

R3 series I/O module: PC configuration software (model: R3CON)

Internal bus communication cycle: Approx. 1 msec.

Status indicator: RUN, RD, SD, D LINK, ERR, L ER, LINK
(Refer to the instruction manual.)

CC-Link IE TSN

Protocol: IEEE 802.3

Transmission type: 1000BASE-T

Communication speed: 1 Gbps

Communication method: Time sharing method

Synchronization function: IEEE802.1AS and IEEE1588v2 compliant

Certification class: Class B

Network cable: Cable conformed to CC-Link IE Field

Double shielded twist pair cable (CAT5e)

RJ-45 connector

Network topology: Line, star and ring

Max. number stations: 64770 (Total master and slave station)

(Number of max. connectable slaves may vary depending on the master module. Refer to the instruction manual of the master module)

Max. station-to-station distance: 100 m

Station type: Remote station

Link device: RX/R Y 112 points, RWw/RWr 64 points

(Number of points summation of I/O module for R30 series and R3 series)

INSTALLATION

Current consumption: ≤ 160 mA
Operating temperature: -10 to +55°C (14 to 131°F)
Storage temperature: -20 to +65°C (-4 to +149°F)
Operating humidity: 10 to 90 %RH (non-condensing)
Atmosphere: No corrosive gas or heavy dust
Mounting: Installation Base (model: R30BS)
Weight: 125 g (0.28 lb)

PERFORMANCE

Insulation resistance: ≥ 100 M Ω with 500 V DC
Dielectric strength: 1500 V AC @ 1 minute (CC-Link IE TSN to internal bus or internal power)
 1500 V AC @ 1 minute (power input to FE; isolated on the power supply module)

STANDARDS & APPROVALS

Refer to the manuals to comply with the standards.

EU conformity:

EMC Directive
 EMI EN 61000-6-4
 EMS EN 61000-6-2
 RoHS Directive

EXTERNAL VIEW

FRONT VIEW

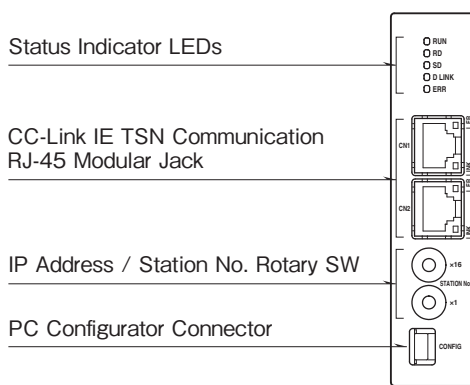

SIDE VIEW

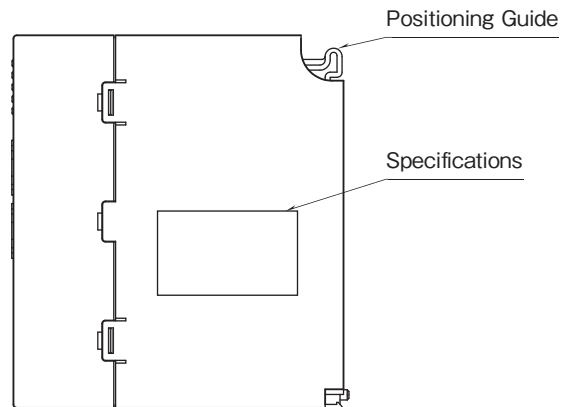

BOTTOM VIEW

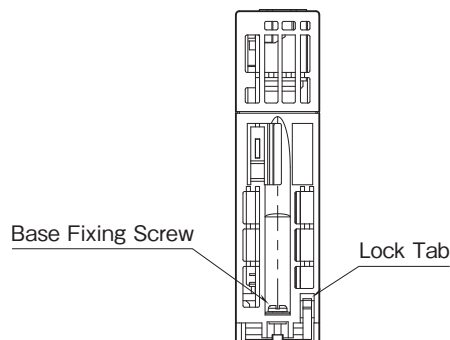

DATA ALLOCATION

This unit recognize type of I/O module (number of occupied station) configured the same base, and assign it to I/O Modules data with slot order automatically. However, I/O module assignment is performed only when power is turned on, in the case of changing configuration of I/O module, please turn on power again.

Keep number of station occupied of I/O module under 64, because max number of occupied station is 64 per a node. When the I/O module has space, data is transmitted close to HOST PC/PLC.

Station type: Remote station

Link device: RX/RX 128points, RWw/RWr 64points

(Points are total of R30 series and R3series module)

E.g. I/O data is assigned as shown below in the case of following configuration.

BASE	SLOT NUMBER	MODEL	NUMBER OF OCCUPIED STATION
R30BS08	PWR	R30PS1	—
	COM	R30NCIT1	—
	1	R30SV4	4
	2	R30US2	2
	3	R30TS4	4
	4	R30YV4	4
	5	R30XN16A	1
	6	R30XN16A	1
	7	R30YN16A	1
R30EBS04	1	R3-SV8	8
	2	R3-YV8	8
	3	R3-DA32A	2
	4	R3-DC32A	2

INPUT DATA

The figure below shows the data sent from the device to the master.

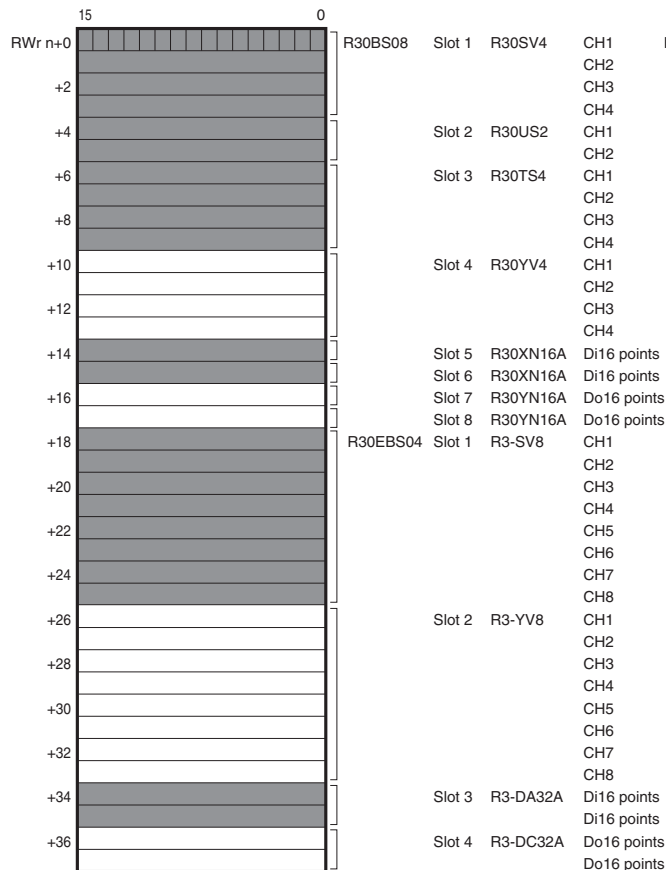

OUTPUT DATA

The figure below shows the data received from the master.

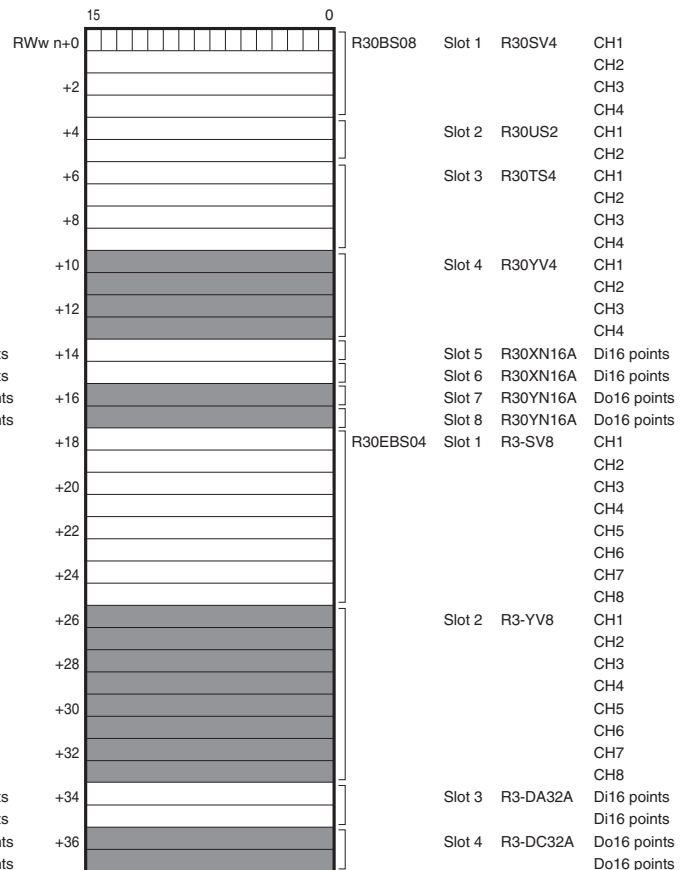

■ STATUS DATA

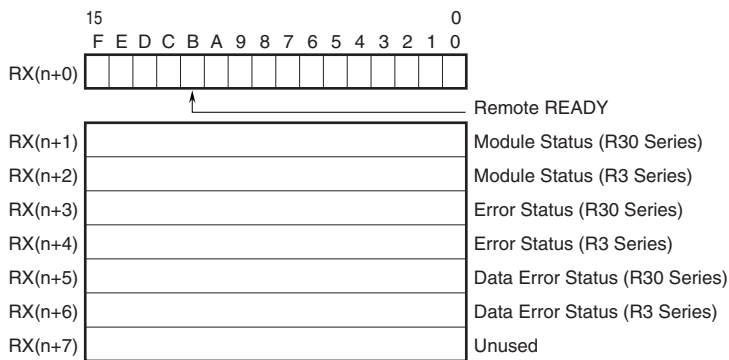

- RX(n+0)0 to 7 is reservation area, RX(n+0)B is used as Ready signal, the bit is “1” when this module is in normal. RX(n+0)8 to A, RX(n+0)C to F are not used.
When the Ready signal is 0, current input data and status are not reflected correctly.
When the Ready signal is 1, input data and status are determined valid data.

- **Module Status**

RX(n+1)0 to RX(n+1)F indicate whether individual I/O modules of R30 series are mounted or not .
RX(n+2)0 to RX(n+2)F indicate whether individual I/O modules of R3 series are mounted or not.
The bit corresponding to the mounted slot turns to “1”, and the unmounted slot to “0”.

- **Error Status**

RX(n+3)0 to RX(n+3)F indicate error status for each module of R30 series.
The bit corresponding to such module turns to “1”, as described below.
When the each module is detached, the error bit is cleared.
However, when the last module is detached, the error bit is held.
R30X16(under development) input power in error or disconnected.
R30Y16(under development) output current in error (e.g. load unconnected)
RX(n+4)0 to RX(n+4)F indicate error status for each module of R3 series.
The bit corresponding to such module turns to “1”, as described below.
When the each module is detached, the error bit is held.
R3-TSx, R3-RSx, R3-US4 input burnout
R3-DA16A input power in error or disconnected
R3-YSx output current error (e.g load unconnected)
R3-PC16A external power supply in error or disconnected

- **Data Error Status**

RX(n+5)0 to RX(n+5)F indicate data error status for each module of R30 series.
The bit corresponding to such module turns to “1”, as described below.
When the each module is detached, the error bit is cleared.
However, when the last module is detached, the error bit is held.
Input value is out of -15% to 115%
R30TS4, R30RS4, R30USx input burnout
RX(n+6)0 to RX(n+6)F indicate error status for each module of R3 series.
The bit corresponding to such module turns to “1”, as described below.
When the each module is detached, the error bit is held.
Input value is out of -15% to 115%
In the case of R3-US4 (voltage input) input level out of -10% to 110%.

RX(n+1)0, RX(n+3)0, RX(n+5)0	R30 series slot 1
RX(n+1)1, RX(n+3)1, RX(n+5)1	R30 series slot 2
RX(n+1)2, RX(n+3)2, RX(n+5)2	R30 series slot 3
:	:
RX(n+1)F, RX(n+3)F, RX(n+5)F	R30 series slot 16
RX(n+2)0, RX(n+4)0, RX(n+6)0	R3 series extension slot 1
RX(n+2)1, RX(n+4)1, RX(n+6)1	R3 series extension slot 2
RX(n+2)2, RX(n+4)2, RX(n+6)2	R3 series extension slot 3
:	:
RX(n+2)F, RX(n+4)F, RX(n+6)F	R3 series extension slot 16

Link devices other than the above are not in use.

I/O DATA DESCRIPTIONS

■ OPERATION IN CASE OF A COMMUNICATION ERROR WITH I/O MODULES

When the communication between the network module and the I/O modules is lost due to an error in an input module, the last process values are held until the communication is re-established.

■ MODULE STATUS, ERROR STATUS, DATA ERROR STATUS

Shows each module's availability and error status.

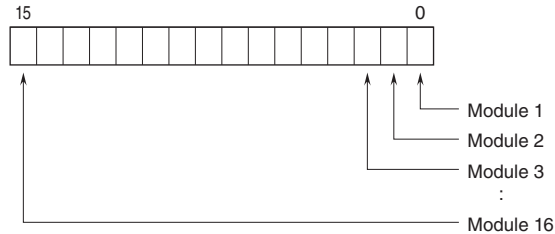

■ ANALOG DATA (16-bit data, models: R30SV4, R30SV2, R30YV4, R30YS4, R30US4, etc.)

16-bit binary data.

Basically, 0 to 100% of the selected I/O range is converted into 0 to 10000 (binary).

Negative percentage is represented in 2's complements.

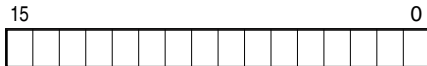

■ ANALOG DATA (16-bit data, models: R30RS4, R30TS4, R30US4, etc.)

16-bit binary data.

With °C temperature unit, raw data is multiplied by 10. For example, 25.5°C is converted into 255.

With °F temperature unit, the integer section of raw data is directly converted into the data.

For example, 135.4°F is converted into 135.

Minus temperature is converted into negative values, represented in 2's complements.



■ ANALOG DATA (16-bit data, models: R30CT4E etc.)

16-bit binary data.

Integer obtained by multiplying unit value (A) by 100.

In case of CLSE-R5, integer obtained by multiplying unit value (A) by 1000.



■ ANALOG DATA (16-bit data, models: R3-PA2, PA4A, WT1, WT4, etc.)

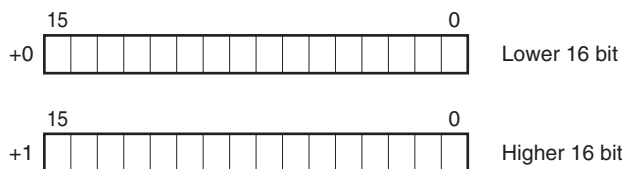

32-bit binary data is used for accumulated counts, encoder positions, and active energy.

Lower 16 bits are allocated from the lowest address to higher ones, higher 16 bits in turn.

32-bit data cannot be accessed using floating addresses.

■ ANALOG DATA (32-bit data, models: R3-BA32A, BC32A, etc.)

32-bit binary data is used for BCD.

Lower 16 bits are allocated from the lowest address to higher ones, higher 16 bits in turn.

32-bit data cannot be accessed using floating addresses.

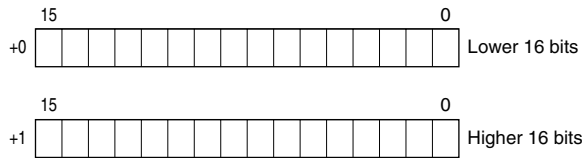

■ 16-POINT DISCRETE DATA (models: R30XN16A, R30YN16x, etc.)

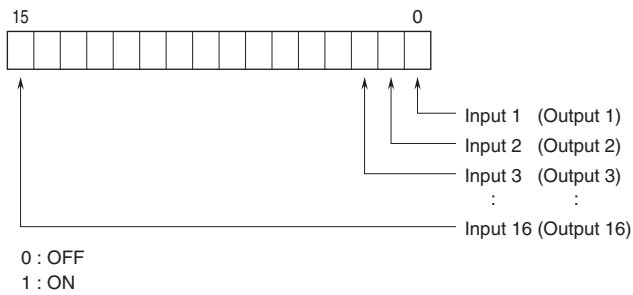

EXTERNAL DIMENSIONS unit: mm [inch]

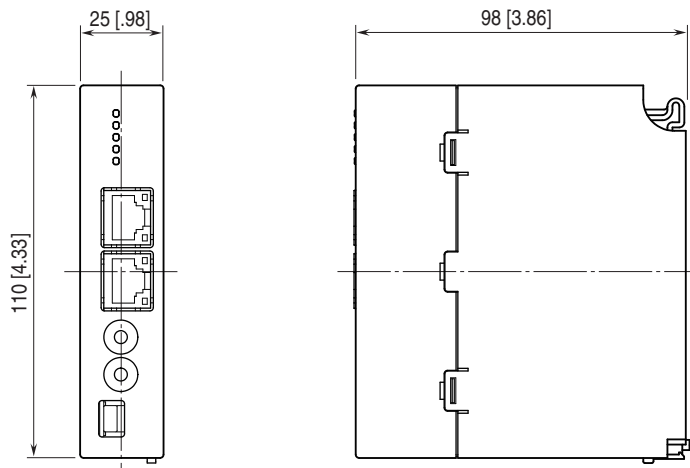

SCHEMATIC CIRCUITRY & CONNECTION DIAGRAM

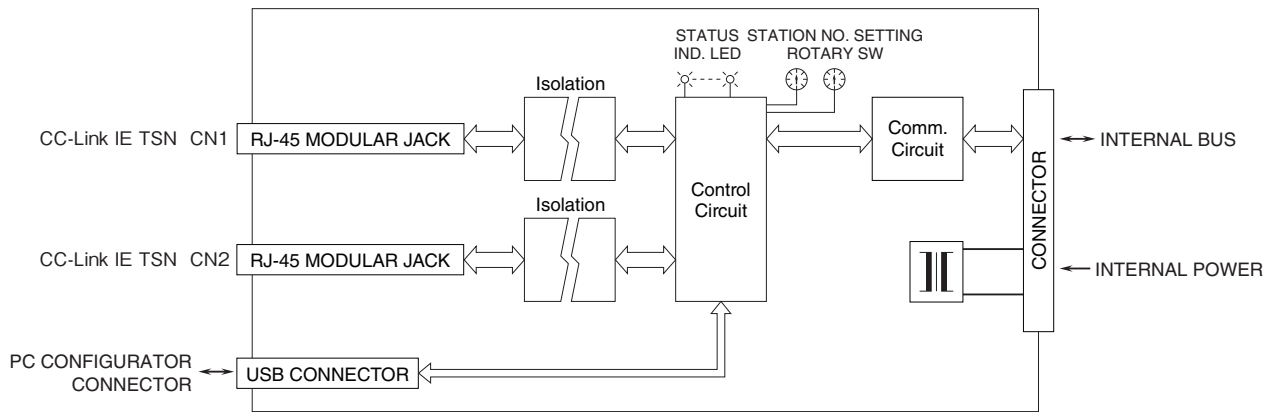

Regarding CN1 and CN2 of RJ-45 connector for CC-Link IE TSN network, there is no restriction for connection order.



Specifications are subject to change without notice.