

**Dual Output Plug-in Signal Conditioners W-UNIT**

**ENCODER SIGNAL DISTRIBUTOR**

(rotary encoder use)

**Functions & Features**

- Isolating two phase pulse input signals from a rotary encoder and distributing them to two outputs (input frequency = output frequency)
- Various outputs (open collector, voltage pulse, RS-422 line driver pulse)
- Can be used as a pulse isolator of two different I/O specs
- Converting RS-422 line driver pulse into an open collector pulse
- Isolation up to 2000 V AC
- Maximum frequency of 1 MHz

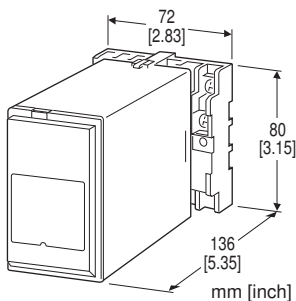

**MODEL: WRPP-[1][2][3][4]-[5][6]**

**ORDERING INFORMATION**

- Code number: WRPP-[1][2][3][4]-[5][6]
- Specify a code from below for each of [1] through [6]. (e.g. WRPP-JJJN-R/Q)
- Specify the specification for option code /Q (e.g. /C01/S01)

**[1] INPUT**

- A1:** Dry contact
- K:** 3.3 V pulse
- C:** 5 V pulse
- D:** 12 V/24 V pulse
- J:** RS-422 line driver pulse

**[2] OUTPUT 1**

- A:** Open collector (max. frequency 100 kHz)
- K:** 3.3 V pulse (max. frequency 1 MHz)
- M:** 5 V pulse (max. frequency 500 kHz)
- N:** 12 V pulse (max. frequency 100 kHz)
- J:** RS-422 line driver pulse (max. frequency 1 MHz)

**[3] OUTPUT 2**

- A:** Open collector (max. frequency 100 kHz)
- K:** 3.3 V pulse (max. frequency 1 MHz)
- M:** 5 V pulse (max. frequency 500 kHz)
- N:** 12 V pulse (max. frequency 100 kHz)
- J:** RS-422 line driver pulse (max. frequency 1 MHz)

**[4] OUTPUT LOGIC (both Input 1 & 2)**

- N:** The same as the input
- R:** Inverted

**[5] POWER INPUT**

- AC Power**
- M2:** 100 - 240 V AC (Operational voltage range 85 - 264 V, 47 - 66 Hz)
- DC Power**
- R:** 24 V DC (Operational voltage range 24 V ±10 %, ripple 10 %p-p max.)
- R2:** 11 - 27 V DC (Operational voltage range 11 - 27 V, ripple 10 %p-p max.) (CE not available)
- P:** 110 V DC (Operational voltage range 85 - 150 V, ripple 10 %p-p max.)

**[6] OPTIONS**

- blank:** none
- /Q:** With options (specify the specification)

**SPECIFICATIONS OF OPTION: Q (multiple selections)**

- COATING** (For the detail, refer to our web site.)
- /C01:** Silicone coating
- /C02:** Polyurethane coating
- /C03:** Rubber coating
- TERMINAL SCREW MATERIAL**
- /S01:** Stainless steel

**GENERAL SPECIFICATIONS**

- Construction:** Plug-in
- Connection:** M3.5 screw terminals
- Screw terminal:** Chromated steel (standard) or stainless steel
- Housing material:** Flame-resistant resin (black)
- Isolation:** Input to output 1 to output 2 to power
- Input monitor LED:** Available to check input pulse existence
- Input pulse sensing:** DC coupled

**INPUT SPECIFICATIONS**■ **Dry Contact****Max. frequency:** 100 kHz**Input requirements****Sensing:** 5 V DC / 10 mA**Detecting level:**OFF:  $\geq 3.0 \text{ V} / \geq 750 \Omega$ ON:  $\leq 2.0 \text{ V} / \leq 333 \Omega$ 

Sensing voltage/current shows the excitation supply to the input terminal and the current value at the time of shortcircuit.

Detecting level shows the threshold used to determine ON or OFF status of the pulses and the resistance values of the dry contact of that time.

■ **Voltage Pulse****Waveform:** Square or sine• **3.3 V Pulse****Max. frequency:** 1 MHz**Input impedance:** Approx. 8 k $\Omega$  100 pF**Max. voltage between terminals (pulse):** -10 - +15 V**Max. voltage between terminals (DC):** -5 - +10 V DC**Detecting level:**  $V_H \geq 2.0 \text{ V}$ ,  $V_L \leq 1.3 \text{ V}$ • **5 V Pulse****Max. frequency:** 500 kHz**Input impedance:** Approx. 14 k $\Omega$  100 pF**Max. voltage between terminals (pulse):** -10 - +15 V**Max. voltage between terminals (DC):** -5 - +10 V DC**Detecting level:**  $V_H \geq 3.0 \text{ V}$ ,  $V_L \leq 2.0 \text{ V}$ • **12 V, 24 V Pulse****Max. frequency:** 100 kHz**Input impedance:** Approx. 20 k $\Omega$ **Max. voltage between terminals (pulse):** -30 - +50 V**Max. voltage between terminals (DC):** -30 - +50 V DC**Detecting level:**  $V_H \geq 7.0 \text{ V}$ ,  $V_L \leq 5.0 \text{ V}$ ■ **RS-422 Line Driver Pulse****Maximum frequency:** 1 MHz**Receiver:** Conforms to RS-422

(No receiving resistor incorporated)

**OUTPUT SPECIFICATIONS**■ **Open collector****Max. frequency:** 100 kHz**Rating:** 50 V DC @ 100 mA**Saturation voltage:** 0.12 V DC■ **Voltage Pulse:** Rating (3.3, 5 or 12 V)  $\pm 20 \%$ **Max. frequency ; Load resistance** (the lower value of either this or the maximum frequency of the input signal)3.3 V 1 MHz ; 660  $\Omega$ 5 V 500 kHz ; 1 k $\Omega$ 12 V 100kHz ; 2.4 k $\Omega$ **Low level:**  $\leq 0.5 \text{ V}$ ■ **RS-422 Line Driver Pulse:** Conforms to RS-422**Max. frequency:** 1 MHz**Output current:**  $\pm 20 \text{ mA}$ **INSTALLATION****Power Consumption**• **AC:**

Approx. 4 VA at 100 V

Approx. 5 VA at 200 V

Approx. 6 VA at 240 V

• **DC:** Approx. 3 W**Operating temperature:** -5 to +55°C (23 to 131°F)**Operating humidity:** 30 to 90 %RH (non-condensing)**Mounting:** Surface or DIN rail**Weight:** 250 g (0.55 lb)**PERFORMANCE****Response time delay**

• 3.3 or 5 V voltage pulse or RS-422 line driver pulse:

Approx. 0.15 - 0.5  $\mu\text{sec}$ .• 12 V voltage pulse or open collector: 0.2 - 2  $\mu\text{sec}$ .**Insulation resistance:**  $\geq 100 \text{ M}\Omega$  with 500 V DC**Dielectric strength:** 2000 V AC @1 minute (input to output 1 to output 2 to power to ground)**STANDARDS & APPROVALS****EU conformity:**

EMC Directive

EMI EN 61000-6-4

EMS EN 61000-6-2

Low Voltage Directive

EN 61010-1

Installation Category II

Pollution Degree 2

Input or output 1 or output 2 to power input:

Reinforced insulation (300 V)

Input to output 1 to output 2: Basic insulation (300 V)

RoHS Directive

**EXTERNAL VIEW**

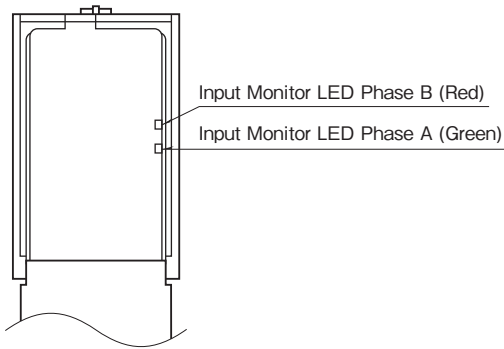

**OUTPUT LOGIC**

Applicable for both Output 1 and 2.

| Input \ Output                                     |              | Voltage pulse<br>RS-422 line driver pulse | Dry contact |
|--|--------------|---|-------------|
|  |              | H<br>L                                    | OFF<br>ON   |
| Voltage pulse<br>or<br>RS-422 line<br>driver pulse | Non-inverted | H<br>L                                    | H<br>L      |
|  | Inverted     | H<br>L                                    | H<br>L      |
| Open collector                                     | Non-inverted | OFF<br>ON                                 | OFF<br>ON   |
|  | Inverted     | OFF<br>ON                                 | OFF<br>ON   |

**EXTERNAL DIMENSIONS & TERMINAL ASSIGNMENTS unit: mm [inch]**

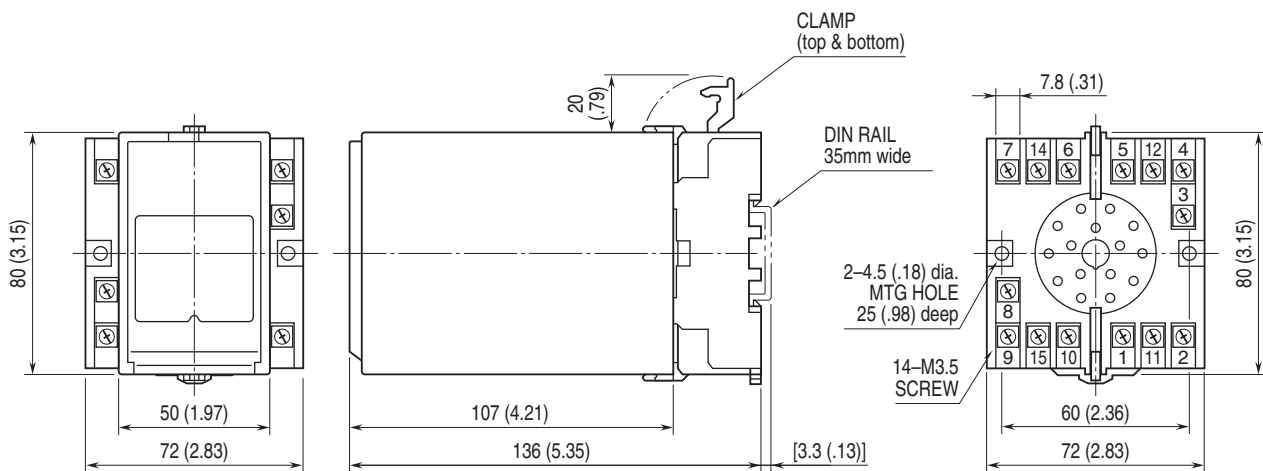

• When mounting, no extra space is needed between units.

## SCHEMATIC CIRCUITRY & CONNECTION DIAGRAM

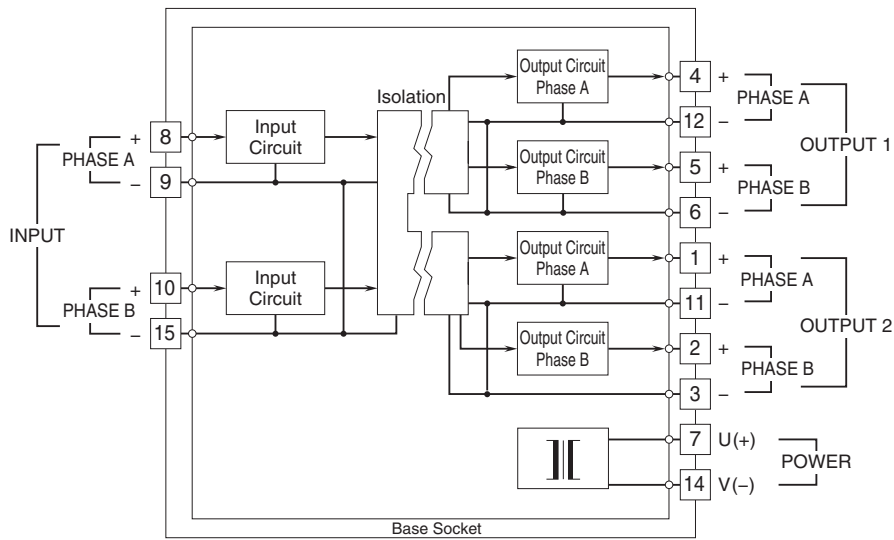

### Input Connection Examples

#### ■ Dry Contact Input

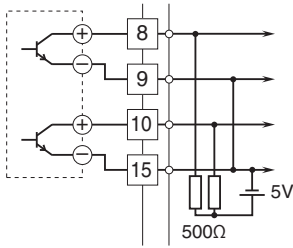

#### ■ Voltage Pulse Input

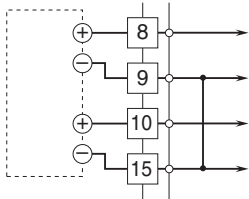

#### ■ RS-422 Line Driver Pulse Input

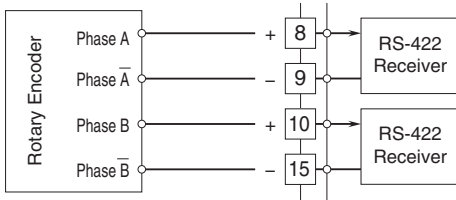

### Output Connection Examples

#### ■ Open Collector Output

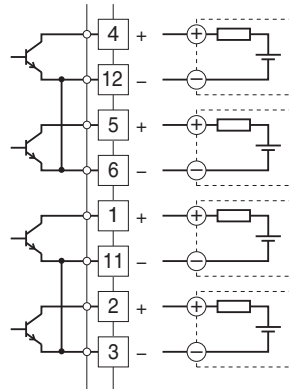

#### ■ Voltage Pulse Output

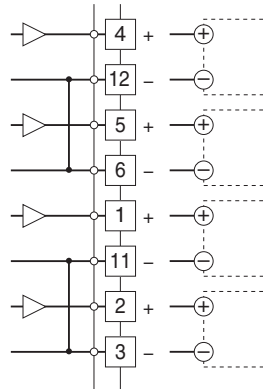

#### ■ RS-422 Line Driver Pulse Output

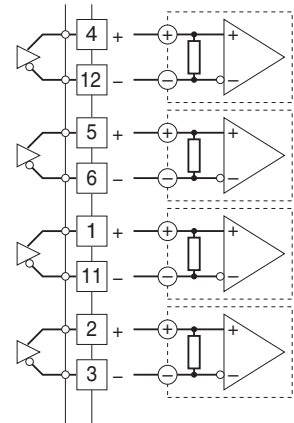

Specifications are subject to change without notice.