

Plug-in Remote I/O R10 Series

MODBUS I/O MODULE

(2 points, universal input)

Functions & Features

- Plug-in construction
- Modbus-RTU protocol communication
- Universal input configurable to T/C, RTD, potentiometer, resistor, DC current or voltage independently
- High-density mounting

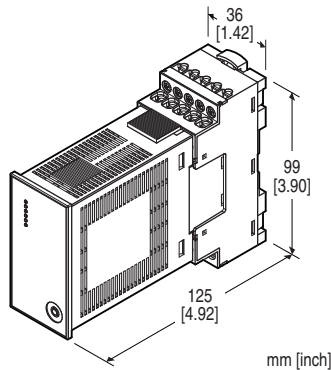

Note: The figure shows the combination of the unit and the base.

MODEL: R10M-US2-R[1]

ORDERING INFORMATION

- Code number: R10M-US2-R[1]
- Specify a code from below for [1].
(e.g. R10M-US2-R/Q)
- Specify the specification for option code /Q
(e.g. /C01)

I/O TYPE

US2: Universal input, 2 points

POWER INPUT

DC Power

R: 24 V DC

(Operational voltage range 24 V \pm 10 %, ripple 10 %p-p max.)

[1] OPTIONS

blank: none

/Q: With options (specify the specification)

SPECIFICATIONS OF OPTION: Q (multiple selections)

COATING (For the detail, refer to our web site.)

/C01: Silicone coating

/C02: Polyurethane coating

/C03: Rubber coating

RELATED PRODUCTS

- Installation base (model: R10-BS)
- PC configurator software (model: R10CFG)

The configurator software is downloadable at our web site. A dedicated cable is required to connect the module to the PC. Please refer to the internet software download site or the users manual for the PC configurator for applicable cable types.

PACKAGE INCLUDES...

- Terminating resistor 110 Ω (0.25W)
- Cold junction sensor: 2

GENERAL SPECIFICATIONS

Construction: Plug-in

Connection

- Connected to base with connector
- Base

M2.6 screw terminals (torque: 0.5 N·m)

Applicable solderless terminal size (M3)

Screw terminal: Nickel-plated steel

Housing material: Flame-resistant resin (black)

Isolation: Input to Modbus to power input to FE1

Burnout (T/C, RTD, potentiometer, resistor input): Selectable among with burnout or no burnout with PC configurator software (model: R10CFG)

Linearization (T/C, RTD input): Standard tables stored in memory

Cold junction compensation (T/C): CJC sensor (included) to be attached to the input terminals

Status indicators: Power, Run, Error

Configuration: Select sensors for 2 points each with PC Configurator Software (model: R10CFG)

■ Recommended solderless terminal size - M3 (unit: mm)

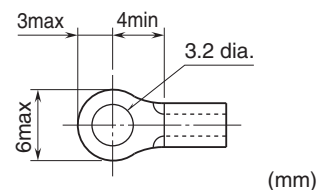

MODBUS COMMUNICATION

RS-485

Standard: Conforms to TIA/EIA-485-A

Protocol: Modbus-RTU, Modbus-ASCII

Transmission distance: 500 meters max.

Transmission media: Shielded twisted-pair cable

(CPEV-S 0.9 dia.)

Status indicator LED: RD, SD

Transmission setting: PC configurator software

Dielectric strength: 1500 V AC @ 1 minute (input to Modbus to power input to FE1)

INPUT SPECIFICATIONS

Input setting: Configurable via PC Configurator Software

■ Universal Input

No. of points: 2

•DC current input

Input resistance: Input resistor (49.9 Ω) incorporated

Input range: 0 - 20 mA

•DC voltage input range (-1000 - +1000 mV)

Input resistance: ≥ 10 K Ω

•DC voltage input range (-10 - +10 V)

Input resistance: ≥ 1 M Ω

•Thermocouple input

Input resistance: ≥ 10 k Ω

Input range: See Table 1

Burnout sensing: $\leq 4\mu$ A

Conformance range: See Table 1

•RTD input (2- or 3-wire)

Input sensing: ≤ 0.33 mA

Input range: See Table 1

Maximum leadwire resistance: 20 Ω per wire (for 3-wire)

•Resistor input

Input sensing: ≤ 0.33 mA

Input range: 0 - 4000 Ω

Maximum leadwire resistance: 20 Ω per wire (for 3-wire)

•Potentiometer input

Input sensing: ≤ 0.33 mA

Input range: 0 - 4000 Ω

INSTALLATION

Current consumption: ≤ 90 mA

Operating temperature: -10 to +55 $^{\circ}$ C (14 to 131 $^{\circ}$ F)

Storage temperature: -10 to +55 $^{\circ}$ C (14 to +131 $^{\circ}$ F)

Operating humidity: 10 to 90 %RH (non-condensing)

Atmosphere: No corrosive gas or heavy dust

Mounting: Installation Base (model: R10BS)

Weight: 120 g (0.26 lb) except base

PERFORMANCE

Accuracy: See Table 1.

Cold junction compensation error (thermocouple input):

$\pm 2.0^{\circ}$ C at 0 - 50 $^{\circ}$ C ($\pm 3.6^{\circ}$ F at 32 - 122 $^{\circ}$ F)

CJC sensor is adjacently attached to the input terminals.

Temp. coefficient: ± 0.03 %/ $^{\circ}$ C (± 0.02 %/ $^{\circ}$ F)

Burnout response (potentiometer, resistor, thermocouple,

RTD input): ≤ 10 s

Insulation resistance: ≥ 100 M Ω with 500 V DC

STANDARDS & APPROVALS

EU conformity:

EMC Directive

EMI EN 61000-6-4

EMS EN 61000-6-2

RoHS Directive

INPUT TYPE, RANGE & CONVERSION ACCURACY

[Table 1]

INPUT TYPE		INPUT RANGE				CONVERSION ACCURACY			
DC Current		0 - +20 mA DC				±20 µA			
DC Voltage		-1000 - +1000 mV DC				When maximum input*2 is 60 mV or less: ±80 µV When maximum input*2 is 120 mV or less: ±150 µV When maximum input*2 exceeds 120 mV: ±1 mV			
		-10 - +10 V DC				±10 mV			
Potentiometer*3		0 - 300Ω, 0 - 600Ω, 0 - 4000Ω				Larger value of either ±0.1 Ω or ±0.1 %			
Resistor*3		0 - 4000Ω				Larger value of either ±0.1 Ω or ±0.1 %			
Thermocouple*3		°C				°F			
		Input range	Usable range	Conv. accuracy*1	Comformance range	Input Range	Usable range	Conv. accuracy*1	Comformance range
		0 - 1760	-50 - 1810	±2.0	0 - 1760	32 - 3200	-58 - +3290	±3.6	32 - 3200
K		-270 - +1370	-273.2 - +1420	±1.0	-150 - +1370	-454 - +2498	-460 - +2588	±1.8	-238 - +2498
E		-270 - +1000	-273.2 - +1050	±1.0	-170 - +1000	-454 - +1832	-460 - +1922	±1.8	-274 - +1832
J		-210 - +1200	-260 - +1250	±1.0	-180 - +1200	-346 - +2192	-436 - +2282	±1.8	-292 - +2192
T		-270 - +400	-273.2 - +450	±1.0	-170 - +400	-454 - +752	-460 - +842	±1.8	-274 - +752
B		100 - +1820	20 - 1870	±2.0	400 - 1760	212 - 3308	68 - 3398	±3.6	752 - 3200
R		-50 - +1760	-100 - +1810	±2.0	200 - 1760	-58 - +3200	-148 - +3290	±3.6	392 - 3200
S		-50 - +1760	-100 - +1810	±2.0	0 - 1760	-58 - +3200	-148 - +3290	±3.6	32 - 3200
C		0 - 2315	-50 - +2365	±2.0	0 - 2315	32 - 4199	-58 - +4289	±3.6	32 - 4199
N		-270 - +1300	-273.2 - +1350	±1.0	-130 - +1300	-454 - +2372	-460 - +2462	±1.8	-202 - +2372
U		-200 - +600	-250 - +650	±1.0	-200 - +600	-328 - +1112	-418 - +1202	±1.8	-328 - +1112
L		-200 - +900	-250 - +950	±1.0	-200 - +900	-328 - +1652	-418 - +1742	±1.8	-328 - +1652
P		0 - 1395	-50 - +1445	±1.0	0 - 1395	32 - 2543	-58 - +2633	±1.8	32 - 2543
RTD*3		°C				°F			
		Input Range	Usable range	Conv. accuracy*1	Comformance range	Input Range	Usable range	Conv. accuracy*1	Comformance range
Pt 100 (JIS'97, IEC)		-200 - +850	-240 - +900	±1.0	-200 - +850	-328 - +1562	-400 - +1652	±1.8	-328 - +1562
Pt 500		-200 - +850	-240 - +900	±0.5	-200 - +850	-328 - +1562	-400 - +1652	±0.9	-328 - +1562
Pt 1000		-200 - +850	-240 - +900	±0.5	-200 - +850	-328 - +1562	-400 - +1652	±0.9	-328 - +1562
Pt 50Ω (JIS' 81)		-200 - +649	-230 - +700	±2.0	-200 - +649	-328 - +1200	-391 - +1292	±3.6	-328 - +1200
JPt 100 (JIS' 89)		-200 - +510	-235 - +560	±1.0	-200 - +510	-328 - +950	-391 - +1040	±1.8	-328 - +950
Ni 508.4Ω		-50 - +200	-100 - +250	±0.5	-50 - +200	-58 - +392	-148 - +482	±0.9	-58 - +392
Cu 10 (25°C)		-50 - +250	-210 - +300	±3.0	-50 - +250	-58 - +482	-148 - +572	±5.4	-58 - +482

*1. Thermocouple: Cold junction compensation error is not included in above figures. Take it into account when cold junction compensation is enabled.

*2. Maximum input: Absolute value of zero input or full input, whichever is greater.

*3. Burnout (potentiometer, resistor, thermocouple or RTD): -32768 - 32767.

CONFIGURATOR SOFTWARE SETTING

The following parameters can be set with using PC Configurator Software (model: R10CFG)
Refer to the users manual for the R30CFG for detailed operation of the software program.

■ UNIVERSAL INPUT SETTING

Each channel can be set independently.

ITEM	SETTING RANGE	DEFAULT SETTING
Input type	DC Current	0 - 20 mA DC
	DC Voltage	-1000 - +1000 mV DC, -10 - +10 V DC
	Potentiometer	0 - 4000 Ω, 0 - 600 Ω, 0 - 300 Ω
	Resistor	0 - 4000 Ω
	Thermocouple	(PR), K (CA), E (CRC), J (IC), T (CC), B (RH), R, S, C (WRe 5-26), N, U, L, P (Platinel II)
	RTD	Pt 100, Pt 500, Pt 1000, Pt 50 Ω, JPt 100, Ni 508.4 Ω, Cu 10 (25°C)
Wiring	2-wire / 3-wire	3-wire
CJC	without / with	with
Temp. unit	°C / °F	°C
Zero input	within the available range	0.000 (mA)
Full input	within the available range (full input ≥ zero input)	20.000 (mA)
Zero fine adj.	-5.00 - 5.00 (%)	0.00(%)
Gain fine adj.	0.9500 - 1.0500	1.0000
Zero scaling	-32000 - 32000	0
Full scaling	-32000 - 32000	10000
Burnout	without / with	with
Burnout value	-32768 - 32767	32767
First-order filter time constant	0.0 - 60.0 (sec.)	0.0 (sec.)

■ MODBUS SETTING

ITEM	SETTING RANGE	DEFAULT SETTING
Data Mode	Modbus-RTU / Modbus-ASCII	Modbus-RTU
Address	1 - 247	1
Baud Rate	38400 / 19200 / 9600 / 4800 bps	38400 bps
Parity	None / Odd / Even	None
Communication timeout duration	0.1 - 3200.0 (sec.)	3.0 sec.

Depending on data mode and parity bit setting, data bit and stop bit are as following.

DATA MODE	PARITY BIT	DATA BIT	STOP BIT
Modbus-RTU	None	8	2
	Odd or Even	8	1
Modbus-ASCII	None	7	2
	Odd or Even	7	1

EXTERNAL VIEW

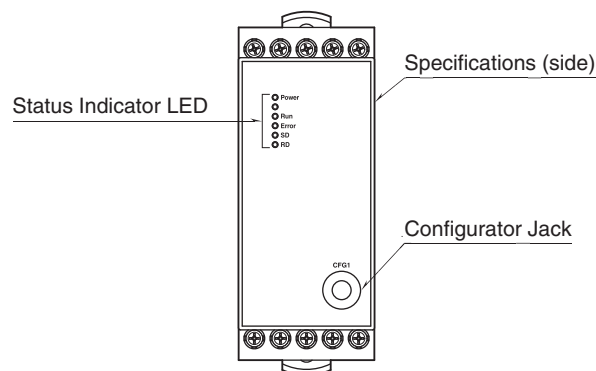

MODBUS WIRING CONNECTION

■ WIRING COMMUNICATION WITH HOST PC

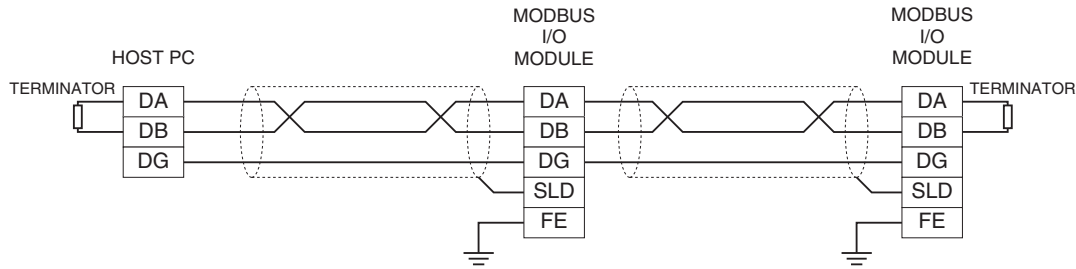

Note: The terminator must be connected across "DA" and "DB" at both ends of communication line.

TERMINAL ASSIGNMENTS

■ BASE

1	2	3	4	5
U1A	U2A	U1B	U2B	NC
6	7	8	9	10
U3A	U4A	U3B	U4B	NC
11	12	13	14	15
FE	DB	DA	NC	FE1
16	17	18	19	20
SLD	DG	NC	24V	0V

PIN NO.	ID	FUNCTION	PIN NO.	ID	FUNCTION
1	U1A	Input 1-U1	11	FE	Modbus grounding
2	U2A	Input 1-U2	12	DB	DB
3	U1B	Input 2-U1	13	DA	DA
4	U2B	Input 2-U2	14	NC	Unused
5	NC	Unused	15	FE1	Power grounding
6	U3A	Input 3-U1	16	SLD	Shield
7	U4A	Input 3-U2	17	DG	DG
8	U3B	Input 4-U1	18	NC	Unused
9	U4B	Input 4-U2	19	24V	Power supply 24V DC
10	NC	Unused	20	0V	Power supply 0V DC

• Universal Input Terminal Assignment

ID	FUNCTION					
	DC Current/DC Voltage (-10 to +10V DC)	DC Voltage (-1000 to +1000mV DC)	Thermocouple	RTD/Resistor (3-wire)	RTD/Resistor (2-wire)	Potentiometer
U1	DC Current/DC Voltage	-	-	-	-	-
U2	-	DC Voltage	Thermocouple +	RTD-b	-	Input S
U3	-	-	CJM	RTD-B	RTD-B	Input L
U4	Common	Common	Thermocouple-, CJM	RTD-A	RTD-A	Input H

MODBUS FUNCTION CODES & SUPPORTED CODES

Modbus function codes are shown below

■ DATA AND CONTROL FUNCTIONS

CODE	NAME	
02	Read Input Status	Status of digital inputs to the slave (read only)
04	Read Input Registers	Collected data from the field by the slave (read only)

■ EXCEPTION CODES

CODE	NAME	
01	Illegal Function	Function code is not allowable for the slave
02	Illegal Data Address	Address is not available within the slave
03	Illegal Data Value	Data is not valid for the function

MODBUS I/O ASSIGNMENT

	ADDRESS	DATA TYPE	DATA
Input (1X)	1		Analog input 1 error (burnout / input range error)
	2		Analog input 2 error (burnout / input range error)
Input Register (3X)	1	I	Analog Input (analog input 1)
	2	I	Analog Input (analog input 2)

Note: DO NOT access addresses other than the ones mentioned above. Such access may cause problems such as malfunction.

■ DATA TYPE

I: Integer, -32768 - 32767

■ STATUS

1 bit: indicates input status.

burnout / input range error (Input range is out of the range -5 to +105% for scaling setting, or out of the range -32768 to +32767)

0: Normal

1: Error

DATA CONVERSION

■ UNIVERSAL INPUT DATA (SCALING CONVERSION DATA, 16 bit)



When scaling setting is initial value, 0 to 10000, data is 0 to 10000 for input 0 to 100% setting.

Input range is -5 to +105% (-500 to +10500). When out of input range, it is fixed to -500 or +10500.

Minus value is converted into negative values, represented in 2's complements.

■ UNIVERSAL INPUT DATA (TEMPERATURE DATA, 16 bit)



When setting both zero input and full input to 0 with thermocouple or RTD input, response it as temperature data.

With °C temperature unit, raw data is multiplied by 10. For example, 25.5°C is converted into 255.

With °F temperature unit, the integer section of raw data is directly converted into the data.

Minus temperature is converted into negative values, represented in 2' s complements.

■ DATA ERROR STATUS (1 bit)

Data error status is indicated by 1 bit.

0: OFF

1: ON

EXTERNAL DIMENSIONS unit: mm [inch]

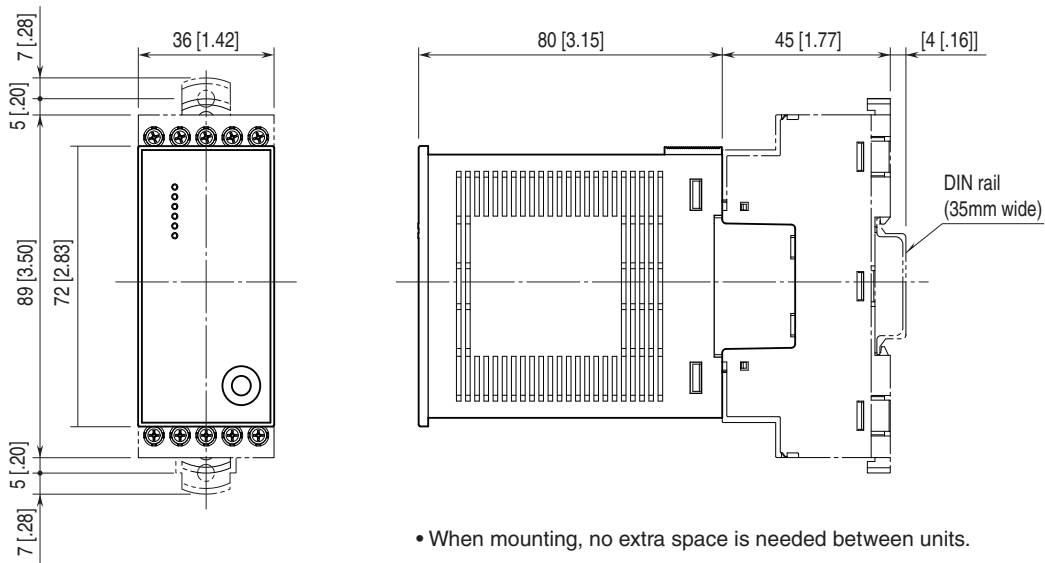

MOUNTING REQUIREMENTS unit: mm [inch]

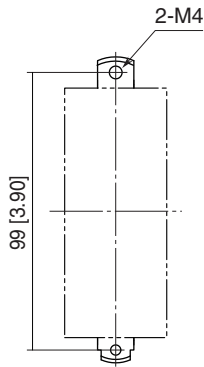

* Mounting requirements for base.

TERMINAL ASSIGNMENTS

CJC sensor attached for a thermocouple input.

■ BASE

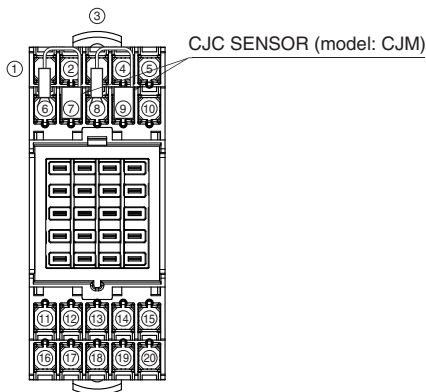

* Base does not come with the unit. Please order separately.

SCHEMATIC CIRCUITRY & CONNECTION DIAGRAM

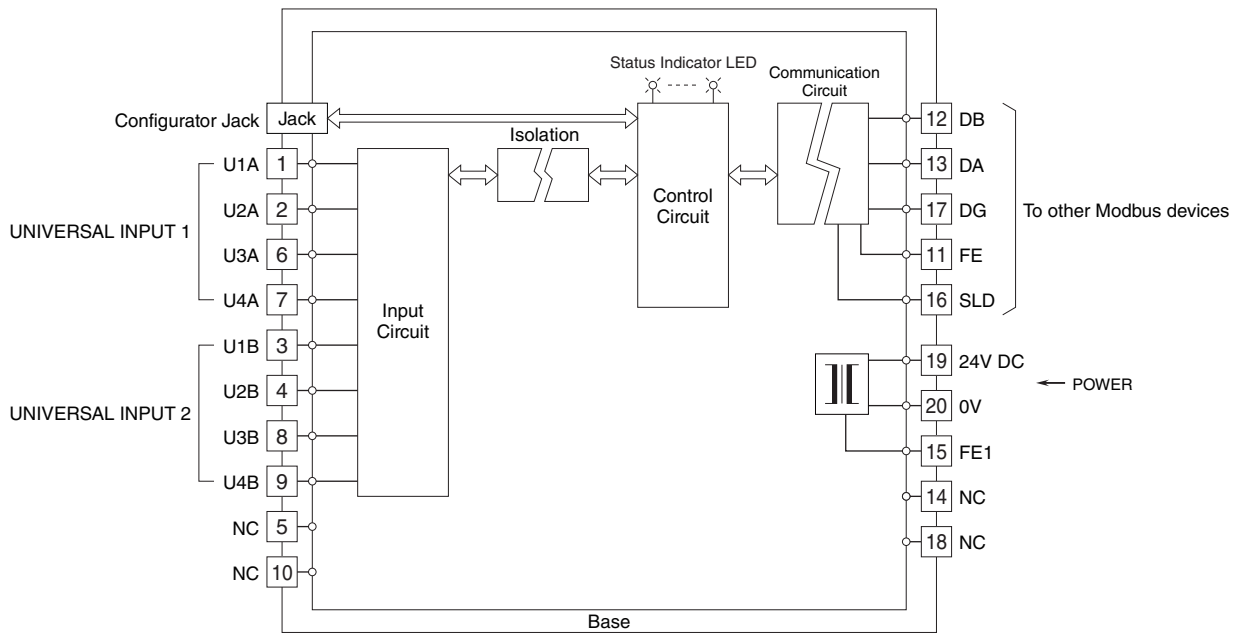

■ UNIVERSAL INPUT CONNECTION

- DC Voltage (-10 – +10V)
- DC Current (0 – 20mA)

- DC Voltage (-1000 – +1000mV)

- Thermocouple

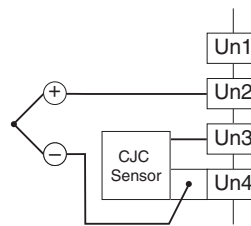
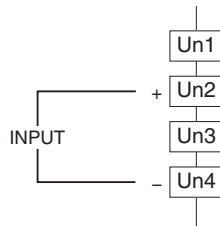
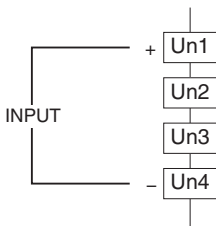

- RTD or Resistor (3-wire)

- RTD or Resistor (2-wire)

- Potentiometer

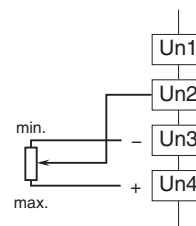
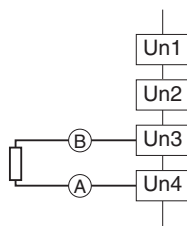
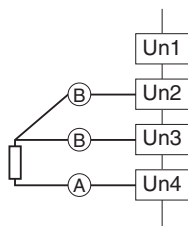

Specifications are subject to change without notice.